



# Installation, Operation, and Maintenance **Symbio™ 800 Controller**



## **▲ SAFETY WARNING**

Only qualified personnel should install and service the equipment. The installation, starting up, and servicing of heating, ventilating, and air-conditioning equipment can be hazardous and requires specific knowledge and training. Improperly installed, adjusted or altered equipment by an unqualified person could result in death or serious injury. When working on the equipment, observe all precautions in the literature and on the tags, stickers, and labels that are attached to the equipment.



## Introduction

Read this manual thoroughly before operating or servicing this unit.

## Warnings, Cautions, and Notices

Safety advisories appear throughout this manual as required. Your personal safety and the proper operation of this machine depend upon the strict observance of these precautions.

The three types of advisories are defined as follows:



Indicates a potentially hazardous situation which, if not avoided, could result in death or serious injury.



Indicates a potentially hazardous situation which, if not avoided, could result in minor or moderate injury. It could also be used to alert against unsafe practices.



Indicates a situation that could result in equipment or property-damage only accidents.

## Important Environmental Concerns

Scientific research has shown that certain man-made chemicals can affect the earth's naturally occurring stratospheric ozone layer when released to the atmosphere. In particular, several of the identified chemicals that may affect the ozone layer are refrigerants that contain Chlorine, Fluorine and Carbon (CFCs) and those containing Hydrogen, Chlorine, Fluorine and Carbon (HCFCs). Not all refrigerants containing these compounds have the same potential impact to the environment. Trane advocates the responsible handling of all refrigerants-including industry replacements for CFCs and HCFCs such as saturated or unsaturated HFCs and HCFCs.

## Important Responsible Refrigerant Practices

Trane believes that responsible refrigerant practices are important to the environment, our customers, and the air conditioning industry. All technicians who handle refrigerants must be certified according to local rules. For the USA, the Federal Clean Air Act (Section 608) sets forth the requirements for handling, reclaiming, recovering and recycling of certain refrigerants and the equipment that is used in these service procedures. In addition, some states or municipalities may have additional requirements that must also be adhered to for responsible management of refrigerants. Know the applicable laws and follow them.

### **⚠ WARNING**

#### **Proper Field Wiring and Grounding Required!**

Failure to follow code could result in death or serious injury.

**All field wiring MUST be performed by qualified personnel. Improperly installed and grounded field wiring poses FIRE and ELECTROCUTION hazards. To avoid these hazards, you MUST follow requirements for field wiring installation and grounding as described in NEC and your local/state/national electrical codes.**

## **⚠ WARNING**

### **Personal Protective Equipment (PPE) Required!**

Failure to wear proper PPE for the job being undertaken could result in death or serious injury.

Technicians, in order to protect themselves from potential electrical, mechanical, and chemical hazards, **MUST** follow precautions in this manual and on the tags, stickers, and labels, as well as the instructions below:

- Before installing/servicing this unit, technicians **MUST** put on all PPE required for the work being undertaken (Examples; cut resistant gloves/sleeves, butyl gloves, safety glasses, hard hat/bump cap, fall protection, electrical PPE and arc flash clothing). **ALWAYS** refer to appropriate Safety Data Sheets (SDS) and OSHA guidelines for proper PPE.
- When working with or around hazardous chemicals, **ALWAYS** refer to the appropriate SDS and OSHA/GHS (Global Harmonized System of Classification and Labelling of Chemicals) guidelines for information on allowable personal exposure levels, proper respiratory protection and handling instructions.
- If there is a risk of energized electrical contact, arc, or flash, technicians **MUST** put on all PPE in accordance with OSHA, NFPA 70E, or other country-specific requirements for arc flash protection, **PRIOR** to servicing the unit. **NEVER PERFORM ANY SWITCHING, DISCONNECTING, OR VOLTAGE TESTING WITHOUT PROPER ELECTRICAL PPE AND ARC FLASH CLOTHING. ENSURE ELECTRICAL METERS AND EQUIPMENT ARE PROPERLY RATED FOR INTENDED VOLTAGE.**

## **⚠ WARNING**

### **Follow EHS Policies!**

Failure to follow instructions below could result in death or serious injury.

- All Trane personnel must follow the company's Environmental, Health and Safety (EHS) policies when performing work such as hot work, electrical, fall protection, lockout/tagout, refrigerant handling, etc. Where local regulations are more stringent than these policies, those regulations supersede these policies.
- Non-Trane personnel should always follow local regulations.

## **Copyright**

This document and the information in it are the property of Trane, and may not be used or reproduced in whole or in part without written permission. Trane reserves the right to revise this publication at any time, and to make changes to its content without obligation to notify any person of such revision or change.

## **Trademarks**

All trademarks referenced in this document are the trademarks of their respective owners.



# Table of Contents

Overview .....	8
Symbio 800 Components .....	8
Specifications .....	9
Dimensions .....	10
Mounting the Symbio 800 .....	10
Battery and Battery Tray .....	10
USB Ports .....	10
Expansion Module Usage .....	11
LEDs and the 7–Segment Display .....	11
Powering Up the Symbio 800 Unit Controller .....	11
The LEDs and the 7–Segment Display .....	11
Interpreting the LEDs .....	12
Interpreting the 7–Segment Display .....	12
Additional Ordering Options .....	14
BTL Certification .....	15
Smoke Control Support (UUKL) .....	15
Enclosures .....	15
Wiring and Powering the Symbio 800 .....	16
Wiring DC Power to Symbio 800 .....	16
Symbio 800 Power Supply Requirements .....	17
Direct Current Requirements for Symbio 800 and Peripherals .....	17
USB Port Power Requirements .....	18
Configuring the Symbio 800 for Communications .....	19
Communication Protocols Supported .....	19
BACnet TP — Setting Addresses Using Rotary Switches .....	19
Device ID Assignment for BACnet TP Devices .....	20
Device ID Assignment for BACnet/IP Devices .....	20
Tracer BACnet Terminator .....	21
LonTalk Network Configuration .....	21
Modbus TCP/RTU .....	21
Setting Up a Trane Wi-Fi Network .....	21
Setup a Wi-Fi Network (Host Mode) .....	22
Using Tracer TU with Symbio 800 .....	23
Using the TD7 or TD12 Display .....	24
Supported Languages .....	24
Security .....	24
Log In .....	24
User ID Screen .....	24

Password Screen.....	25
Screen Overview .....	25
Top Display Area.....	26
Main Display Area (Home Screen) .....	26
Bottom Display Area .....	27
Alarms.....	28
Alarm Screens .....	28
Reports .....	30
Custom Graphics.....	31
Accessing a Graphic .....	31
Custom Reports.....	31
Points .....	34
User Points Report .....	34
Analog Overrides .....	35
Binary Overrides .....	36
Multistate Overrides.....	37
Override Summary.....	38
Active Points Alarms and Event Log .....	38
Expansion Modules .....	40
TGP2 Programs .....	41
Unit.....	42
Ventilation.....	42
Cooling.....	42
Heating.....	42
About .....	42
Operating Modes.....	43
Data Graphs .....	43
Settings .....	47
Supply Fan VFD Bypass .....	48
Entering a Supply Fan VFD Bypass Event.....	49
Exiting a Supply Fan VFD Bypass Event .....	49
Ventilation Override (if configured).....	50
Arbitration Method .....	51
Feature Settings .....	52
Discharge Air Reset .....	52
Manual Control Settings.....	52
Beginning a Manual Override Event .....	54
Display Preference .....	55
Language .....	56
Date and Time.....	57
Clean Touchscreen.....	58
Log Out .....	58
LLID Binding .....	58

Symbio UI .....	59
Connecting to the Symbio UI .....	59
Supported Browsers .....	59
Admin .....	60
Creating a New User .....	60
Assigning Roles to Users .....	60
Creating a New Role .....	60
Setting Password Requirements .....	61
Summary .....	61
Alarms .....	62
Alarm Icons .....	62
Sorting Alarms .....	62
Data Logs .....	63
Viewing Data Logs .....	63
Points .....	64
Deleting Points .....	65
Recycled Points .....	65
Creating a Data Log .....	65
Points Override .....	65
Schedules .....	66
Exceptions and Calendars .....	66
Creating a Schedule .....	66
Alarm Configuration .....	67
Tools .....	67
BACnet® Information .....	68
Firmware Upgrade .....	68
Programs .....	68
Resource Usage .....	69
System Logs .....	69
Installation .....	69
Regional Specifications .....	70
Symbio™ 800 System Units .....	70
Identification and Communications .....	70
USB Ports and microSD .....	71
Licensing .....	71
Defaults for User Preferences .....	72
Application Defaults .....	72
SMTP Settings .....	73
Priority Levels .....	73
Login Page .....	74
Setting Up Trane Connect Remote Access for Customer .....	A-1
Registering a Symbio 800 with TIS Command Center .....	A-1
Modifying a Previously Registered Symbio 800 .....	A-2

Creating Initial Customer Account.....	A-4
Initial Login to Trane Connect.....	A-7
Creating Additional Trane Connect Users.....	A-7
Security.....	A-9
Troubleshooting.....	B-1
Communication Problems.....	B-1
Output Points.....	B-1
Force Return to Factory Defaults (Using 999).....	B-2
Recovery (USB Memory Stick and 997 or 998).....	B-2
Reload Application Firmware.....	B-2
Firmware Updates.....	C-1
Symbio UI.....	C-1



# Overview

The Symbio™ 800 unit controller is a factory-installed, application specific, and programmable controller designed to control chillers, air-handlers, and large-packaged HVAC equipment.

The optional user interface features a touch sensitive color screen that provides the facility manager at-a-glance operating status, performance monitoring, scheduling changes, and operating adjustments. Additional advanced features include automated controller backup, and optional features such as secure remote connectivity, wireless building communications, mobile device connectivity, and custom programming with expandable inputs/outputs (I/O).

**Note:** The Symbio 800 is factory mounted on a variety of equipment and supports different displays (TD7 or TD12). Installations have different factory programming and slightly different Symbio UI screen views. This document often uses an IntelliPak rooftop in many of the examples, but applies to a wide variety of equipment.

## Symbio 800 Components

The Symbio 800 system controller is equipped with the components shown in the following figure. The table that follows provides descriptions.

**Figure 1. Symbio 800 components**

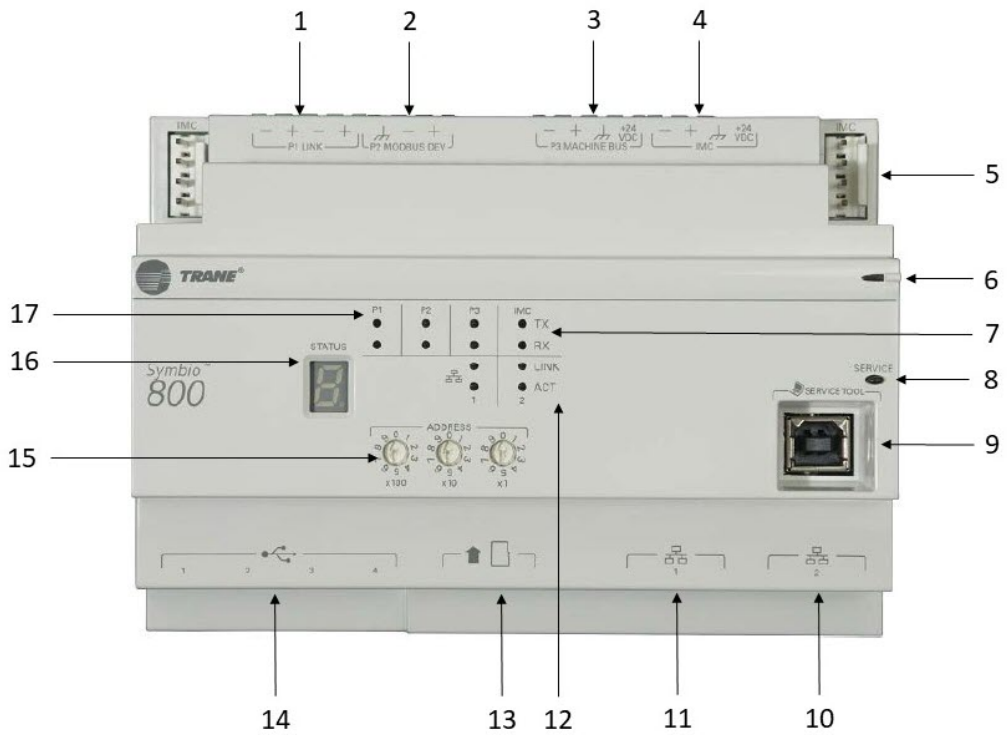

Callout Number in Figure	Symbio 800 Components Description
1	Communication Link P1: RS-485 port configurable for BACnet MS/TP or Modbus RTU
2	Communication Link P2: Modbus Server (Trane approved and factory installed)
3	Communication Link P3: LLID Bus
4	4-pin IMC terminal block port
5	IMC pin connection on each side of the controller



Callout Number in Figure	Symbio 800 Components Description
6	Status LED
7	IMC LEDs
8	Service button and LED <b>Note:</b> Pressing the Service button turns the LED on. The button has no field function. It may be used for advanced service by Trane technical support.
9	USB service tool port for Tracer TU or Web UI at address 198.80.18.1
10	Ethernet network connection 2: supports Trane TD7 or TD12 display at 198.80.18.9
11	Ethernet network connection 1: supports TCP/IP, BACnet/IP, and Modbus TCP communication
12	Ethernet LEDs, Ports 1 and 2 link activity
13	Micro SD card slot: support for backups (up to 10 backup files, FIFO)
14	USB 2.0 ports: support for Tracer USB LonTalk module, WiFi, LTE Modem, and USB mass storage
15	Rotary switches
16	7-segment display
17	RS-485 communication link LEDs

## Specifications

Tracer Symbio 800 conforms to the specifications shown in the following table.

**Table 1. Specifications**

Storage	
Temperature:	-67°F to 203°F (-55°C to 95°C)
Relative humidity:	Between 5% to 95% (non-condensing)
Operating	
Temperature:	-40°F to 158°F (-40°C to 70°C)
Humidity:	Between 5% to 95% (non-condensing)
Power:	Input: If the max operating temperature is 60°F or less, the current draw for the Symbio 800 is 400mA at 24VDC, which includes up to 1000mA of current supplied to the USB host ports. See Symbio 800 Power Requirements for more information.
Time Clock:	On-board real time clock with battery backup
Mounting weight of controller:	Mounting surface must support 1.3 lb. (0.6 kg)
Environmental rating (enclosure):	NEMA 1, IP3x (ingress protection)
Installation:	UL 840: Category 3
Pollution:	UL 840: Degree 2
Processor	Arm A9 Cortex Dual Core
Memory	FLASH 4 GB eMMC SDRAM 1 GB DDR3
Agency Listings	<ul style="list-style-type: none"> <li>UL916 PAZX, Open Energy Management Equipment</li> <li>UL94-5VA Flammability</li> <li>CE</li> <li>FCC Part 15, Subpart B, Class B Limit</li> <li>BTL Listed - B-BC, B-ACC See Symbio 800 BTL listing for details.</li> </ul>

## Dimensions

Figure 2. Symbio 800 dimensions

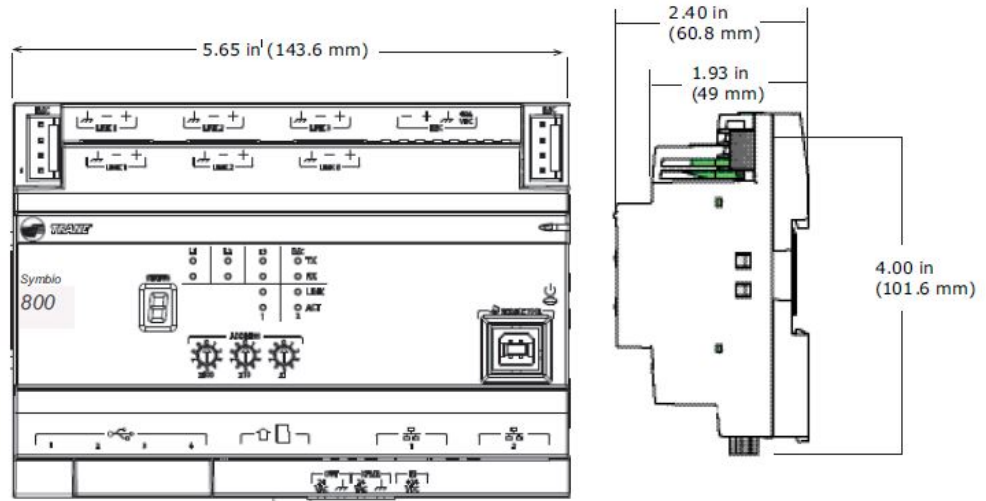

## Mounting the Symbio 800

The Symbio 800 unit controller mounts on the standard 35mm DIN rail. No other means of mounting the controller is provided.

## Battery and Battery Tray

The battery (BR2032 3 V) backs up the internal real-time clock over power fail. Under normal operating conditions, the battery life is 10 years.

**Note:** When replacing the battery or closing the battery tray, have the Symbio 800 controller powered up to maximize battery life.

Figure 3. Symbio 800 battery tray location



## USB Ports

The Symbio 800 USB 2.0 ports support the Tracer USB LonTalk module, WiFi module, LTE Modem, and USB mass storage.

**Notes:**

- USB ports are not designed to charge cell phones or other high-current loads.
- High speed (480 Mbps) and full speed (12 Mbps) are supported.

## Expansion Module Usage

The Symbio 800 unit controller has no on-board I/O points and relies on expansion modules for all I/O. XM30, XM32, XM70, and XM90 expansion modules can be used in any combination. The Symbio 800 controller will support up to 500 combined I/O terminations. See the *Tracer Expansion Module IOM*, (BAS-SVX46), for application and installation information.

Factory-mounted Symbio 800 unit controllers on chillers or IntelliPak rooftop units support a maximum of 120 points. The LLID points do not count towards the 120 point maximum.

Factory-mounted Symbio 800 controllers on Climate Changer air handlers support the Symbio Options Module on the IMC link in addition to the XM modules. A maximum of 500 points are supported in any combination. Factory-mounted Symbio 800 controllers on air handlers do not use LLIDs.

**Note:** Field installation of the Symbio 800 is not supported.

## LEDs and the 7-Segment Display

This section describes how to interpret the activity of the Symbio 800 LEDs and the 7-segment display.

### Powering Up the Symbio 800 Unit Controller

The Symbio 800 controller powers up automatically when power is applied. It is not necessary to press the Service button to power up the controller.

All LEDs illuminate and the following sequence flashes on the 7-segment display: 8, 7, 9, 5, 4, L, dancing dash pattern. The dancing dashes persist while the Symbio 800 is operating normally.

### The LEDs and the 7-Segment Display

The LEDs and the 7-segment display on the Symbio 800 indicate the operation and communication status of the Tracer building automation system. The following figure and the corresponding table show their locations on the front of the controller.

**Figure 4. Location of LEDs and the 7-segment display on the Symbio 800**

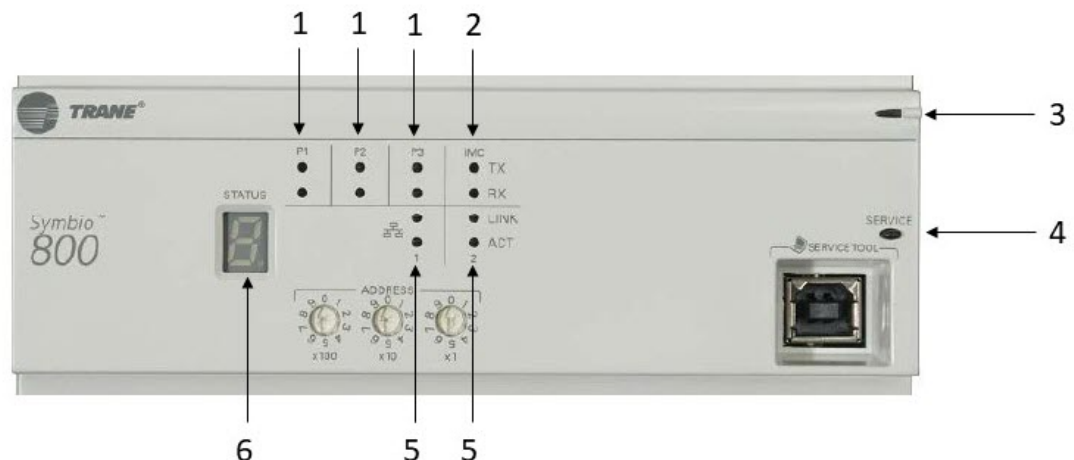

Callout Number in Figure	Description
1	Communication link LEDs
2	IMC link and LEDs
3	Status LED
4	Power button
5	Ethernet LEDs
6	7-segment display

## Interpreting the LEDs

The following table identifies the LEDs and interprets their activity.

**Table 2. LED identification and interpretation**

LED type	LED activity	Indicates...
Status	On steady (green)	Power reception
	Flashing (red) and the three dancing bars appear in the 7-segment display	An active Alarm exists
	Flashing (red), and an "F" appears on the 7-segment display followed by a code	Fatal error. Service required.
	Flashing (red), and an "H" appears on the 7-segment display followed by a code	Hardware failure. Symbio 800 will probably need to be replaced.
P1 communication	L1 TX flickers (green)	Data transmission
	L1 RX flickers (yellow)	Data reception
P2 communication	L2 TX flickers (green)	Data transmission
	L2 RX flickers (yellow)	Data reception
P3 communication	L3 TX flickers (green)	Data transmission
	L3 RX flickers (yellow)	Data reception
IMC	IMC TX (green)	Data transmission
	IMC RX (yellow)	Data reception
Ethernet 1, Ethernet 2	LINK on steady (green)	Valid Ethernet connection
	ACT flickers (yellow)	Data transmission and reception

## Interpreting the 7-Segment Display

The 7-segment display shows the operating status of the Symbio 800 as described in the following table.

**Note:** Many of the 7-segment codes Power Up or Normal Communication. Many of the codes are diagnostic in nature. For example, during a firmware update, many codes are displayed as the update progresses. This is normal.

**Table 3. 7-segment display: Codes and interpretation**

Red/Green LED	7-segment display	Indicates...
None	8	Processor in reset, or no functioning software. A persistent "8" means that service is required.
None	7	Starting boot loader.
Red	5	Entering operating system. A persistent "5" means the operating system is malfunctioning.

**Table 3. 7-segment display: Codes and interpretation (continued)**

Red/Green LED	7-segment display	Indicates...
Red	4	Booting operating system.
Flashing Red	Corner Dashes	Operating system booted. Preparing to start main program.
Green	-L	Starting main program and loading database.
Green	"Dancing dash" dashes flash one at a time: top, middle, bottom	Normal operation.
Green	3,-,2,-,1,- (sequence repeats)	Power button was pressed and Symbio 800 is shutting down. May take 10 or more seconds.
Green	3,2,1 (sequence repeats)	Main program shutting down due to reboot command. In most cases, the main program will be restarted.
Green	Single digit during operation	Rotary switch was changed. The new setting of the changed switch is displayed on the 7-segment LED for several seconds.
Flashing Red	ForCE.	We are waiting for the user to change the rotary settings from 999 in order to force a return to factory defaults.
Flashing Red	CLEAR.	We are clearing the database and returning to factory defaults as directed by the user.
Flashing Red	r.	We are restoring a database per a user database restore operation.
Flashing Red	donE.	The controller is done performing the requested update and needs a manual restart.
Flashing Red	HoLd.	The main program has "crashed" too many times in the last 24 hour period and the controller is now in a "hold" mode.
Flashing Red	rEC.	The controller is booted into recovery mode.
Flashing Red	U0.	Waiting for USB drives to mount.
Flashing Red	F0.	Unknown rotary switch setting.
Flashing Red	U12.	Searching for scfx files.
Flashing Red	F12.	No scfx files found.
Flashing Red	F13.	More than one scfx file found.
Flashing Red	U2.	Checking signature on scfx file.
Flashing Red	U21.	Decrypting scfx file.
Flashing Red	F21.	Invalid scfx file signature by trusted signer.
Flashing Red	F22.	Untrusted signer signed scfx file.
Flashing Red	F23.	No valid signature.
Flashing Red	F24.	No signature data.
Flashing Red	F25.	Invalid or unreadable key or certificate file.
Flashing Red	F26.	Invalid or unreadable input data file.
Flashing Red	F27.	Missing or invalid data in input file.
Flashing Red	F29.	Unknown signature format.
Flashing Red	F212.	Internal error.
Flashing Red	U3.	Checking software maintenance plan.
Flashing Red	F30.	Cannot mount update file. File may be corrupt.
Flashing Red	F31.	Update not allowed by SMP expiration.
Flashing Red	F32.	Internal error.

**Table 3. 7-segment display: Codes and interpretation (continued)**

Red/Green LED	7-segment display	Indicates...
Flashing Red	F33.	License check could not load version file.
Flashing Red	F34.	Licenses on this Symbio 800 are invalid.
Flashing Red	F35.	Version file has an unknown format.
Flashing Red	F36.	Internal error.
Flashing Red	F39.	The update file is not appropriate for this device (trying to use an SC+ file on a Symbio 800, for example).
Flashing Red	U4.	Reformatting main file system (clearing database).
Flashing Red	F41.	Could not reformat main file system (probably hardware failure).
Flashing Red	F42.	Could not mount main file system (probably hardware failure).
Flashing Red	F43.	Unknown update method.
Flashing Red	U5.	Beginning firmware update.
Flashing Red	U51.	Updating main firmware.
Flashing Red	U54.	Updating FPGA image.
Flashing Red	F54.	Updating FPGA image failed.
Flashing Red	U55.	Updating image.
Flashing Red	F55.	Updating image failed.
Flashing Red	U57.	Updating recovery image.
Flashing Red	F57.	Updating recovery image failed.
Flashing Red	F86.	Application exited abnormally.

## Additional Ordering Options

Additional ordering options are available for the Symbio 800:

- Tracer TD7 Operator Display (order number: X13651571010)
- TD7 Sealed Ethernet cable (for wet environments) (order number: X19070632020)
- TD7 Mounting Bracket (flat surface, fixed position) (order number: X05010511010)
- Tracer XM30 expansion module (order number: X13651537010)
- Tracer XM32 expansion module (order number: X13651563010)
- Tracer XM70 expansion module (order number: X13651568010)
- Tracer XM90 expansion module (order number: X13651673010)
- Tracer BACnet Term (2 pack) (order number: X1365152401)
- Trane Large enclosure 120 Vac with display capable door (order number: X13651552010)
- Trane Large enclosure 230 Vac with display capable door (order number: X13651554010)
- Trane Medium enclosure 120 Vac (order number: X13651559010)
- Trane Medium enclosure 230 Vac (order number: X13651560010)
- Trane Small 10" DIN Rail enclosure (order number: X19091354010)
- Power Supply 24 Vac to 1.4A 24 Vdc for XM modules exceeding Symbio 800 power budget (order number: X1365153801)
- IMC Harness (order number: S3090059462)
- Trane LON U60 Adapter (order number X13651698001)

- Trane Wi-Fi Module - Extended Ambient - 2 meter cable (order number X139651725001 if ordered before mid-year 2021. X1365743002 after mid-year 2021.)
- Air-Fi Module - Field Installed (possible order numbers X13790901030, X13790941030, X13790963030, X13790964030)

## **BTL Certification**

The Symbio 800 is primarily listed as a B-AAC listed device intended for equipment control applications only. The Symbio 800's internal BACnet code module meets B-BC compliance standards. However, the Symbio 800 controller is not certified as a B-BC controller. It is strongly advised not to use the Symbio 800 as a building controller.

## **Smoke Control Support (UUKL)**

The Tracer Symbio 800 controller is not UL864 certified with the Tracer SC+ system controller. For more information, see the "*Engineered Smoke Control System Applications Guide*" (BAS-APG019).

## **Enclosures**

The Symbio 800 controller must be installed inside an appropriate enclosure.



## Wiring and Powering the Symbio 800

This section provides how to wire and safely power the Symbio 800.

### ⚠ WARNING

#### Hazardous Voltage!

Failure to disconnect power before servicing could result in death or serious injury. Disconnect all electric power, including remote disconnects before servicing. Follow proper lockout/tagout procedures to ensure the power can not be inadvertently energized. Verify that no power is present with a voltmeter.

### ⚠ WARNING

#### Proper Ground Connection Required!

Failure to follow instructions below could result in death or serious injury. After installation, ensure that the 24 VDC power supply is grounded through the controller. Measure the voltage between chassis ground on the controller and any earth-ground terminal. Expected result: VDC <4.0 volt.

## Wiring DC Power to Symbio 800

1. Provide 24 VDC to the ground and +24 VDC terminals of the IMC connector block or IMC Pin header.
2. Ensure the device is properly grounded.

**Important:** *This device must be grounded for proper operation! The factory-supplied ground wire must be connected from any chassis ground connection on the device to an appropriate earth ground (⏏). The chassis ground connection used may be the 24 VDC power supply input at the device, or any other chassis ground connection on the device.*

**Note:** *The device is not grounded through the DIN rail connection nor is the Symbio 800 grounded through the PM014 power supply (if used).*

3. See the specifics for power supply requirements in the following section.



**Figure 5. Wiring DC power to the Symbio 800**

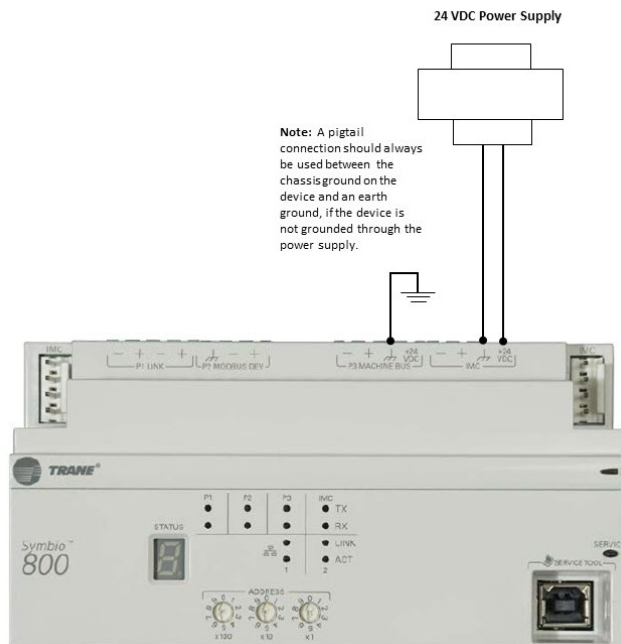

## Symbio 800 Power Supply Requirements

Power the Symbio 800 controller as follows:

- The PM014 power supply module, through inter-module-communication, is the preferred method of powering the Symbio 800 controller.
  - PM014 Output: 1.4 A max at 24 VDC at 70°C. Refer to the *PM014 Power Supply IOM* (BAS-SVX33).
- Any 24 VDC power supply can be used if it has sufficient power output, as shown in [Figure 5, p. 17](#).
  - Any user-provided power supply must provide power for three line cycles if AC power is interrupted. This can prevent controllers from rebooting with shorter, but more frequent, power losses.
- Powering the Symbio 800 from a XM70, or XM90 Expansion Module is not advised.

If the max operating temp is 60°C or less, the current draw for the Symbio 800 is 400mA @24VDC, which includes up to 1000mA of current supplied to the 5 Volt USB Host ports. At max operating temperature of 70°C, the current on the USB Host ports is limited to 500mA. See [Table 4, p. 17](#).

**Table 4. Symbio 800 power draw**

Temperature °C	24 VDC Current (mA)	USB Rated Current (mA)
–40 to 60	400	1,000
60 to 70	300	500

## Direct Current Requirements for Symbio 800 and Peripherals

The Symbio 800 output is 24 Vdc. The table below provides the current draw per component for DC power budgeting.



## Wiring and Powering the Symbio 800

**Table 5. 24 Vdc current draw per component on a Symbio 800 controller**

Component	Current withdraw
Symbio 800 controller	400mA (-40 to 60 Celsius)
WCI	50mA
New WCI (see note)	10mA
Trane BACnet Terminator	8mA
XM30	110mA
XM32	100mA
XM70 and XM90	N/A (both XM70 and XM90 and AC powered devices)

**Note:** New WCI part numbers: X13790901030 (Field Installed Indoor), X13790941030 (Field Installed Outdoor), X13790902030 (Service Indoor Flush), X13790903030 (Factory Indoor), and X13790904030 (Factory Indoor Flush).

### Symbio 800 DC Power Budget

Depending on the power source, Symbio 800 has a maximum current available for peripheral devices. It is a best practice to perform a power budget if you have more than three external devices connected through the IMC.

Using the values from [Table 5, p. 18](#) calculate the power draw for all the components connected to the Symbio 800.

### USB Port Power Requirements

The table below states the 5 Vdc power available for all four USB Ports. No single port can support a sustained load of 500mA, or 510mA intermittent. Overloading a port, or ports may cause the USB load switch to shut down. The USB load switch will shut down very quickly during a direct short circuit.

**Table 6. 5 Vdc current draw per component on the Symbio 800 USB ports**

Component	Current withdraw
Trane Wi-Fi Module (either X13651705001 or X13651743002)	250 mA
Trane U60 LON Adapter	110 mA
Trane USB Cellular Module (Verizon, USA)	450mA



# Configuring the Symbio 800 for Communications

## Communication Protocols Supported

The Symbio 800 controller supports the following communication protocols:

- BACnet TP (Default is 76,800 bps. 19,200, 38,400, 76,800 bps are available.)
- BACnet / Air-Fi
- BACnet / IP (Ethernet Port 1)
- Modbus RTU
- Modbus TCP
- LON via the USB U60 adapter

All Protocols can be configured through the Symbio UI.

**Notes:**

- *Lontalk and Modbus may not be an option on all equipment types and configurations.*
- *The Symbio 800 controller only supports one communication protocol at a time.*

## BACnet TP – Setting Addresses Using Rotary Switches

There are three rotary switches on the front of the Symbio 800 for the purpose of defining a three-digit address when it is installed on a BACnet communications network. The three-digit address setting is used as both the rotary switch value and the BACnet device ID.

For Trane BACnet TP systems, the rotary switch value must be between 1 and 127. Although "0,0,0," is a valid BACnet address, Trane reserves this address for the Tracer SC+ controller. All device addresses on the BACnet TP link must be unique.

- Before powering up the Symbio 800, set the rotary switch value as shown in the following figure.
- If the Symbio 800 was previously powered up, do the following if you wish to make changes:
  - Make the preferred changes to the rotary switch value as illustrated in .
  - Power down the Symbio 800; when re-powered the new rotary switch value should be active.
- For controllers that are connected through BACnet/IP, or wireless via ZigBee™, valid unit controller rotary switch values can range from 001 to 999.

**Note:** Valid rotary switch values used with the Symbio 800 are 001 to 120 for BACnet TP.

**Figure 6. Setting rotary switch values on Symbio 800**

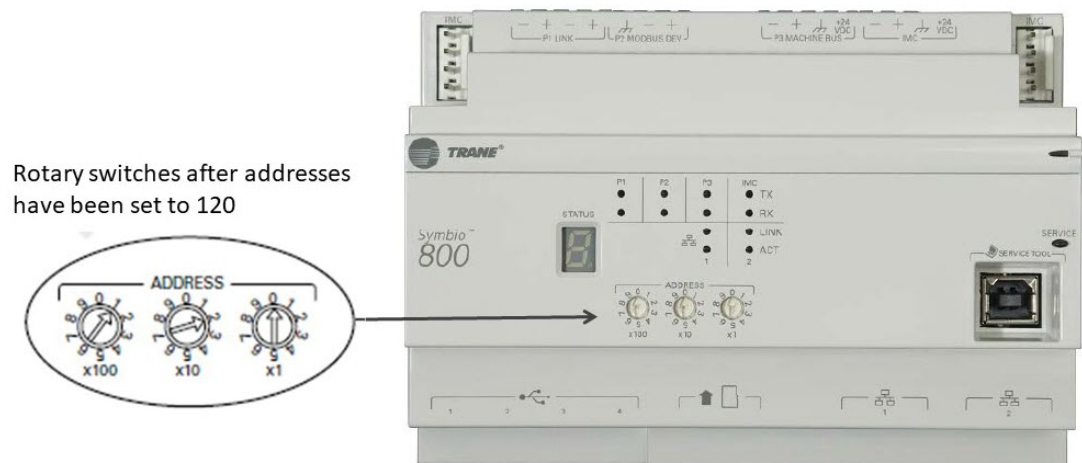

## Configuring the Symbio 800 for Communications

**Important:** Each Symbio 800 device on the BACnet link must have a unique rotary switch value, otherwise communication problems will occur.

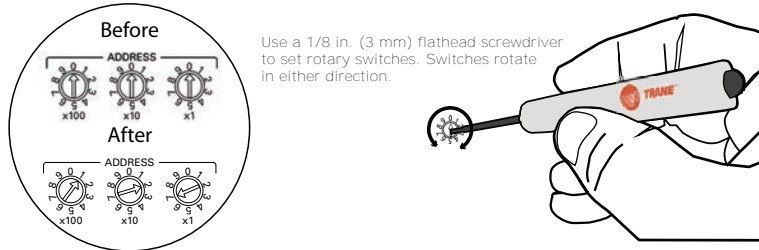

### Device ID Assignment for BACnet TP Devices

Each unit controller must have a unique BACnet device ID. Tracer® SC automates the process by calculating a unique device ID for each unit controller and then saving the device ID to memory in each device.

BACnet TP device IDs are calculated using the following three sets of values:

- The Tracer SC rotary switch value (1 to 419)
- The Tracer SC BACnet TP link number (1 to 2)
- The unit controller rotary switch value (1 to 127)

The three values are joined together to form the BACnet device ID for the unit controller as shown in the following table.

Tracer SC rotary switch value (21)	0	2	1				
Tracer SC BACnet TP link number (1)				1			
Unit controller rotary switch value (38)					0	3	8
<b>BACnet Device ID: 211038</b>	0	2	1	1	0	3	8

### Device ID Assignment for BACnet/IP Devices

Each unit controller must have a unique BACnet device ID. Tracer SC/SC+ automates the device ID assignment process for Trane unit controllers by calculating a unique device ID for each unit controller and then saving the device ID to memory in each device.

For devices communicating over BACnet/IP, Tracer SC/SC+ calculates the device ID using the BACnet network number defined for Ethernet port 1 and the unit controller rotary switch value. The Tracer SC/SC+ rotary switch value is not used in the device ID calculation for IP devices.

BACnet/IP device IDs are calculated using the following two sets of values:

- The BACnet network number for Ethernet 1. (This number can be changed by the user).
  - Tracer SC defaults the BACnet IP network number as 1, and under most circumstances it is not changed.
- The unit controller rotary switch value (1 to 999). The Tracer SC/SC+ rotary address is not used to calculate BACnet/IP device IDs.

The following table shows this process using a Tracer UC600 unit controller.

BACnet network number Eth port 1 (1)		1			
Unit controller rotary switch value (42)			0	4	2
<b>BACnet/IP Device ID: 01042</b>	0	1	0	4	2

## Tracer BACnet Terminator

A Tracer BACnet® terminator is placed at the end of each communication link in order to decrease communication signal degradation. Refer to the *BACnet® Wiring Best Practices and Troubleshooting Guide*, (BAS-SVX51).

**Figure 7. BACnet terminator (wiring)**

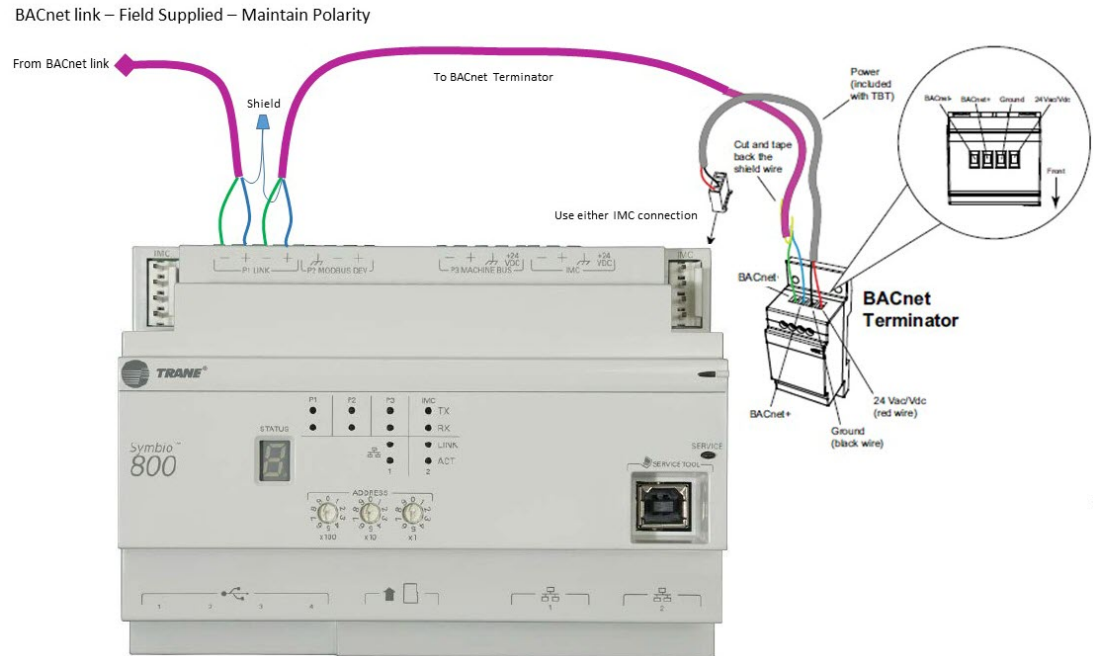

## LonTalk Network Configuration

The Tracer USB LonTalk module (U60) connects to any one of the four USB ports on the Symbio 800 controller. It is configured from the factory to the default DSN A (ZL-255-004) and DSN B (11-255-004) on power up by the Symbio 800 controller. The Rover service tool is used to configure the DSNs.

## Modbus TCP/RTU

The Symbio 800 controller can be configured to be a Modbus RTU or Modbus TCP server. Common applications using Symbio 800 Modbus communications are to communicate to an industrial front end or SCADA (Supervisory Control and Data Acquisition).

Modbus RTU uses 2-wire TIA/EIA-485 communications on the Symbio 800 P1 link. The additional + and – terminals are used to make it easier to daisy chain wire additional Modbus TIA/EIA-485 devices. As per Modbus TIA/EIA communications, only one Modbus RTU client can communicate to the Symbio 800 controller.

Modbus TCP uses Ethernet communications on the Ethernet port 1 of the Symbio 800 controller. Multiple Modbus TCP clients can communicate to the Symbio 800 controller.

**Note:** The Symbio 800 controller uses the P2 Modbus Dev link to communicate to factory installed Modbus RTU server devices. It **cannot** be used for other integration purposes.

## Setting Up a Trane Wi-Fi Network

Trane Wi-Fi modules are supported by Symbio 800 and setup via Symbio UI. Wi-Fi modules only operate as an access point. This can be useful if connecting to the Symbio 800 via Tracer TU or Symbio UI wirelessly.

## Configuring the Symbio 800 for Communications

The only supported mode is Host mode for Symbio 800. This allows a tech to connect to the Symbio 800 over Wi-Fi, but doesn't allow the Symbio 800 to join a customer network or support unit to unit communications over the adapters.

When the Wi-Fi adapter is connected for the first time, Symbio 800 will automatically host a wireless access point with no configuration required. Use the following credentials:

- Default SSID: Trane Wifi <serial number of Symbio 800>
- Default password (to join the hosted network): tracerwifi
- Default IP address: 198.80.18.65
- To join the host network, follow the procedure below.

### Setup a Wi-Fi Network (Host Mode)

1. Navigate to the Wireless Configuration section from the left navigation bar: **Installation > Identification and Communications > IP Configuration**.
2. Click **Edit**. In the **Wi-Fi Network** section, select the check box to enable the network connection, then click **Save**. You are now able to set up the Wi-Fi connection. Select the **Setup Wi-Fi** button. The **Wi-Fi Setup** dialog opens.
3. In the **Mode** section, select **Host (Access Point)**.
4. Enter the IP Address for the Symbio 800 Wif-Fi interface (default is 198.80.18.65).
5. Enter an address for the Subnet Mask (default is 255.255.255.192).
6. Click **Next**.
7. Enter a Network Name (SSID) — default is Tracer WiFi <serial number of Symbio 800>.
8. Enter a Password (default is tracerwifi).
9. Define the Channel of the hosted Wi-Fi network (default is 6).
10. Define the DHCP configuration. This establishes the range of IP address the Symbio 800 will assign to clients that join the hosted network and the duration of each lease. Defaults are shown in [Figure 8, p. 22](#).

**Figure 8. DHCP Configuration (Host Mode)**

DHCP Configuration	
Lease Pool Start Address:	198 . 80 . 18 . 90
Lease Pool End Address:	198 . 80 . 18 . 126
Lease Pool Subnet:	255 . 255 . 255 . 192
Lease Duration (Hours):	24

11. Click **Finish**.

To join the newly created Symbio 800 Host network, connect your computer to the created Wi-Fi network and enter the password (default is tracerwifi). Once you have joined, type the IP address of the Symbio 800 in a web browser. Then, enter a valid user ID and password to interface with Symbio UI.



## Using Tracer TU with Symbio 800

Tracer TU, a software tool that runs on a PC, is primarily used by technicians for advanced tasks. For Tracer TU availability, contact your local Trane sales office. Basic communication setup functions are performed in the Symbio UI.

List of tasks suited for Tracer TU:

- Viewing and accessing devices on wired or wireless networks (links)
- Transferring configurations to controllers
- Modifying controller settings and configurations
- Modifying and overriding points
- Backing up controllers and entire facilities (sites)
- Configuring alarms for points
- Setting up data logs to track and graph specific points
- Installing and discovering expansion modules
- Updating or changing controller firmware
- Performing air and water balancing procedures

See *Tracer TU Service Tool User Guide*, BAS-SVU047, for more information on Tracer TU.



# Using the TD7 or TD12 Display

The Symbio 800 controller can be used with either a TD7 or TD12 display (7" or 12"). For example, Intellipak units use the TD7 and chiller units generally use either the TD7 or TD12. On these units, the display comes standard from the factory with the equipment. The information displayed on the TD7 or TD12 is meant for general status and troubleshooting and is the go-to source of information for the end user of the machinery. No laptop, or hand help device, is necessary to get this information.

Every unit type will have different information on the display. This document is written in a generic sense and cannot cover every possible type or example. However, the examples shown in this section are from an Intellipak rooftop unit (TD7). The intent of this information applies to all unit types.

## Supported Languages

The display supports built-in languages depending on the equipment type and region.

## Security

### Log In

By default, security for the display connection is disabled and the Log In screen is hidden. When security is enabled for the display connection, the display will show the Log In screen. A valid User ID and Password is required to access the status and settings on the display.

Both the User ID and Password screen display the virtual keyboard shown in . The User IDs, Passwords, and password complexity are configured by the Symbio™ UI and can't be configured using the display.

### User ID Screen

To Log In enter a valid User ID. Press Next button to complete the User ID entry and navigate to the Password screen. Press the Clear to erase the User ID.

**Figure 9. User ID screen**

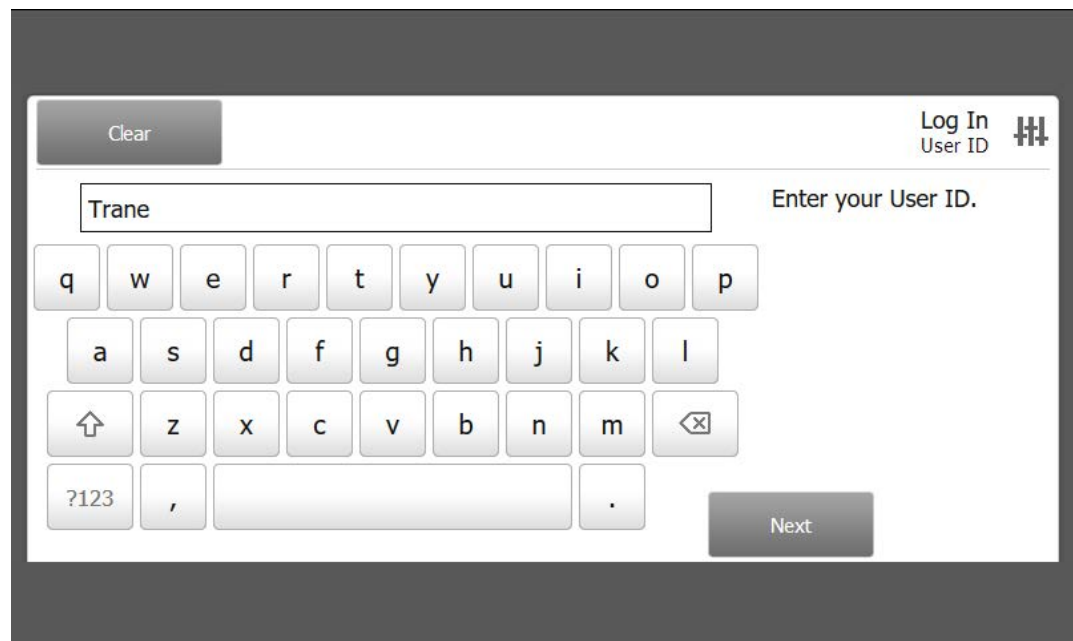



### Password Screen

Enter a valid User ID and Password to unlock the display. Press Log In to complete the Password entry.

- Press Show Password to make the characters entered visible.
- Press Hide Password to display characters as an asterisks (\*).
- Press Cancel to return to the User ID screen.
- Press Clear to erase the Password.

Entering a valid combination of User ID and Password the display will navigate to the home page.

Entering an invalid combination of User ID and password causes the display to show the error message **"The User ID and/or Password is not valid."** and the display will remain on the Password Screen.

**Figure 10. Log In Password screen**

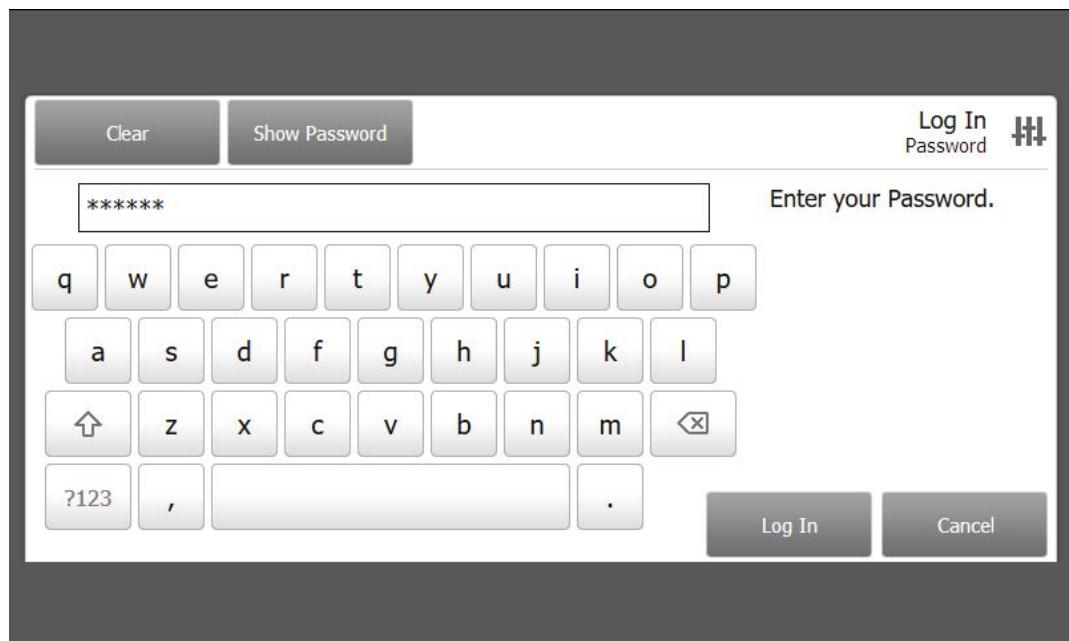

### Screen Overview

There are three distinct areas on the TD7 screens:

- Top display area
- Main display area
- Bottom display area

**Figure 11. TD7 display area**

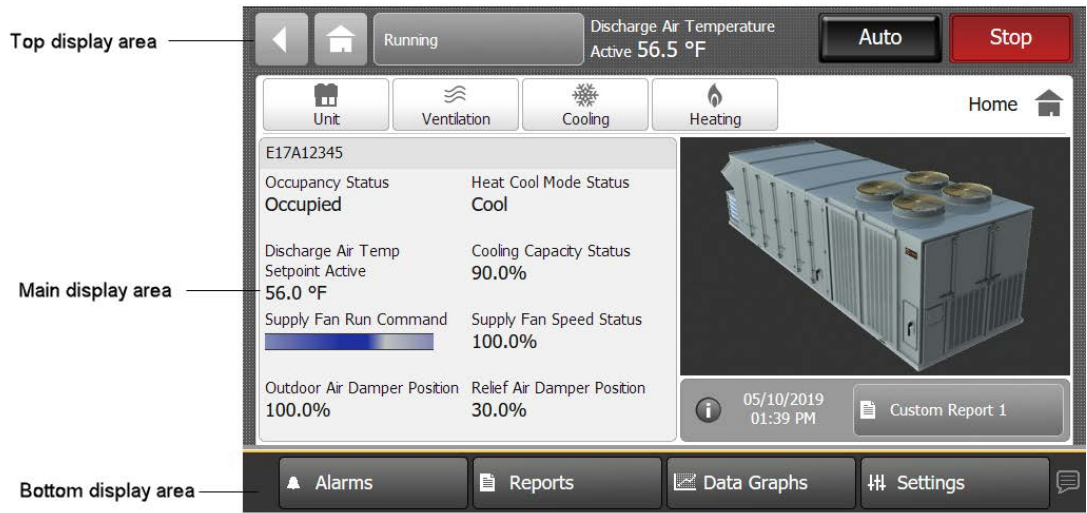

## Top Display Area

**Figure 12. TD7 menu bar**

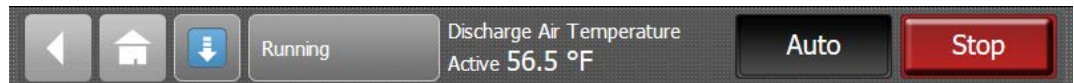

**Table 7. Menu bar buttons**

	The Back button, when touched, returns to the previous screen visited.
	The Home button, when touched, navigates to the home page.
	The Manual Override button, when shown, indicates at least one manual override is active. Touch this icon to navigate to the Manual Control Settings page.
	The Operating Modes button navigates to the Operating Modes screen.
	The Space Temperature Active or Discharge Air Temperature Active, depending on configuration is displayed in the header Data Area.





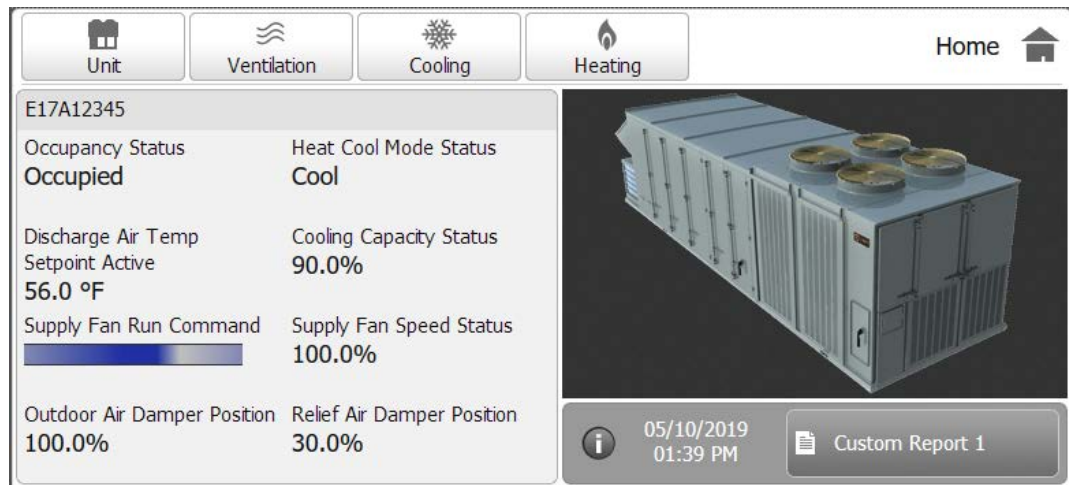

## Main Display Area (Home Screen)

The Home screen is an overview of the unit and its operation. High-level status information is presented so that a user can quickly understand the mode of operation of the unit and navigate quickly to other areas of the display for more detail.

**Figure 13. TD7 Main display area of home screen**





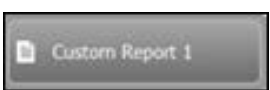



**Table 8. Main display area buttons**

	Touch this button to view the status of unit features.
	Touch this button to view the status of ventilation components.
	Touch this button to view the status of ventilation components.
	Touch this button to view the status of heating components.
	Touch the information icon to view hardware part numbers and software version numbers.
	Touch this button to access the adjust the date and time.
	Touch this button to access Custom Report 1.

## Bottom Display Area

The bottom display area contains functional buttons that provide a link to the appropriate screen.

**Table 9. Bottom display area buttons**

	<p>Screen brightness settings. Set the brightness to 30%, 60%, 90% display back light brightness.</p>
	<p>Touch this button to open the Alarms screen. When an alarm is present, this button will flash.</p>
	<p>Touch this button to navigate to the Reports screen.</p>
	<p>Touch this button to open the Data Graphs screen.</p>
	<p>Touch this button to open the Settings screen, which contains options for manual controls, Feature settings, Binding, Unit Settings, and display settings.</p>
	<p>Language selection: Touch this icon to select a language that will be displayed on all screens.</p>

## Alarms

Equipment level alarms appear on the TD7 display immediately upon detection. Touch the Alarms button in the bottom display area to view the Alarms screen.

### Alarm Screens

When an alarm is present, the Alarm button at the bottom of the TD7 screen will flash. Press this alarm button to display all active alarms. Some alarms will clear automatically and will be removed from this screen. Other alarms require you to press the Reset Alarms button to manually clear the alarm. When the Reset Alarms button is pressed, if the failure condition causing the problem has been removed, the alarm will clear. Otherwise, the alarm will persist.

Pressing the Historic Alarms button displays a list of up to 100 of the past alarms that are no longer active.

The Active Alarms and Historic Alarms screens can be sorted by Target, Severity, Date and Time, or Description by pressing the category in the top row of the alarm list. The sort order can be toggled between ascending and descending order. By default the Alarms are sorted by Date and Time in descending order. The sorted category is highlighted light blue in color and an arrow indicates the direction of the sort.

Figure 14. Active Alarms screen

Reset Alarms

Active Alarms  
3 Active Alarms

!	Target	Severity	Date and Time	Description
!	Unit	Immediate Shutdown	10/23/2018 10:36 AM	Return Air Iso Damper Failed to Open
i	Unit	Warning	10/23/2018 10:36 AM	Relief Air Damper Failed Closed
!	Circuit 1	Normal Shutdown	10/23/2018 10:31 AM	Comm Loss: Reheat Pumpout Solenoid

Active Alarms    Historic Alarms    Page 1 of 2

Alarms    Reports    Data Graphs    Settings

Figure 15. Historic Alarms screen







Historic Alarms  
2 Alarms

!	Target	Severity	Date and Time	Description
i	Unit	Warning	12/20/2018 08:10 AM	Invalid Timed Override Request Active
i	Circuit 2	Warning	12/20/2018 08:10 AM	Comm Loss: VFD Condenser Fan - 1

Active Alarms    Historic Alarms

Alarms    Reports    Data Graphs    Settings

**Table 10. TD7 alarms**

Active Alarm	Historic Alarm	Severity
		Immediate shutdown
		Normal shutdown
		Warning

## Reports

You can use the TD7 display to view a variety of reports and create and edit custom reports.

Touch the **Reports** button in the bottom display area to view the Reports screen.. The Reports screen contains the following buttons:

- Custom Graphics
- Custom Report 1
- Custom Report 2
- Custom Report 3
- Points
- Unit
- Ventilation
- Cooling
- Heating
- About
- Operating Modes

**Figure 16. Reports screen**

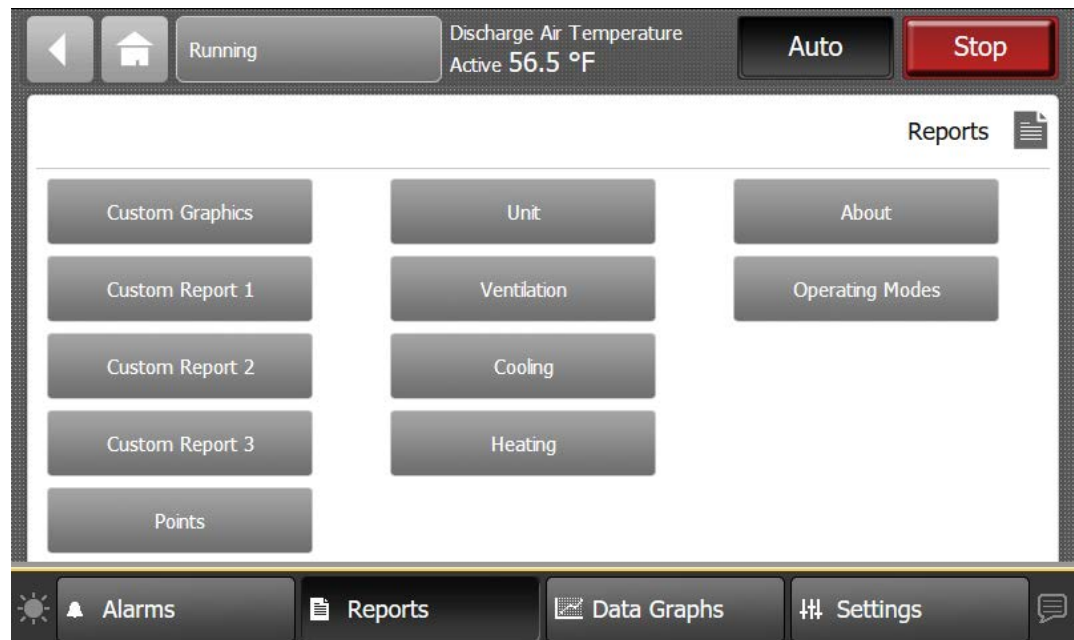

### Custom Graphics

The TD7 Display supports a maximum of 12 custom graphics. Custom graphics are created and loaded using Tracer® Graphics Editor (TGE). See the TGE online help for more information.

Graphics in TD7 allow you to:

- Display the value of any point on the controller
- Display animation items such as fans and dampers
- Perform overrides
- Link to the Alarms page
- Link to the User Points Report and Custom Reports
- Link to another Custom Graphic

### Accessing a Graphic

1. Navigate to the Reports screen, then touch Custom Graphics. The Custom Graphics screen with up to 12 Custom Graphic buttons is shown below. Each button on the screen represents a custom graphic. Custom graphics are published to the Symbio™ 800 Controller using Tracer® Graphics Editor (TGE) in Tracer® TU.
2. Touch the preferred graphic.

**Figure 17. Custom Graphics screen (example)**

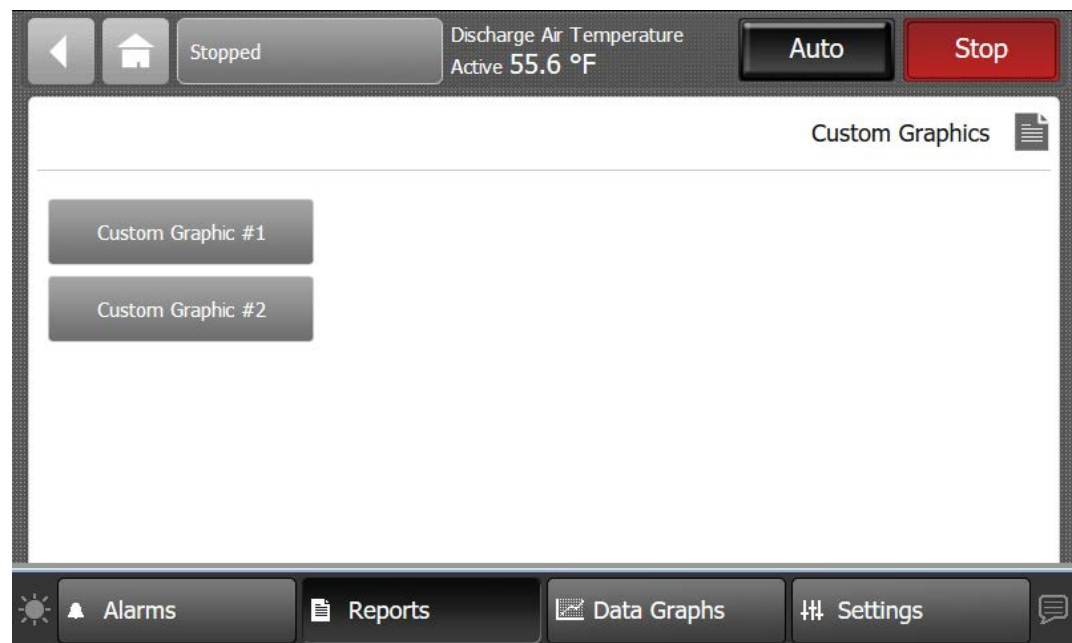

### Custom Reports

You can create up to three custom reports using the TD7 display. Available reports are labeled Custom Report 1, 2, or 3.

#### Creating a Custom Report

1. Navigate to the Reports screen, then touch one of the three custom report buttons. The Custom Report (1, 2, or 3) screen appears.
2. Touch the **Edit** button. The Edit Custom Report screen appears.

**Figure 18. Creating a Custom Report**

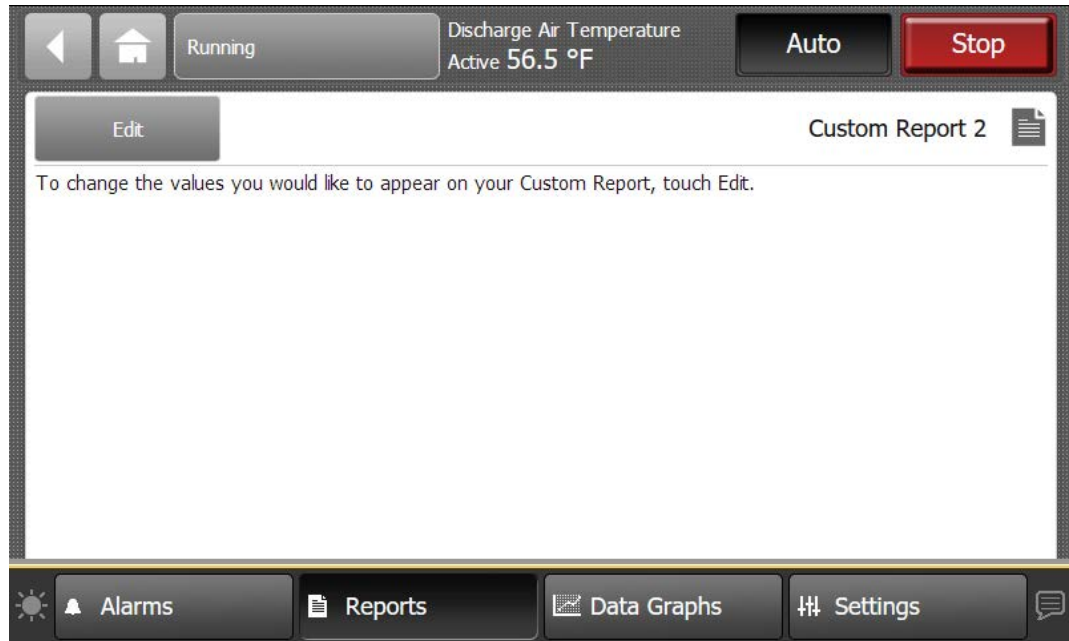

3. Use the up and down arrow buttons to select a data category. Add items by touching the item that is highlighted blue, then touch the **Add** button.
4. Continue adding values to your report. When you are finished, touch the **Save** button. The Custom Report screen, populated with your selected values, appears
5. To view the items in the selected list, touch a value in this list and use the up and down arrows to the right of the list. To change the location of an item in the list, select the item and then use the up and down arrows above the table to move the items.

**Figure 19. New Custom Report screen**

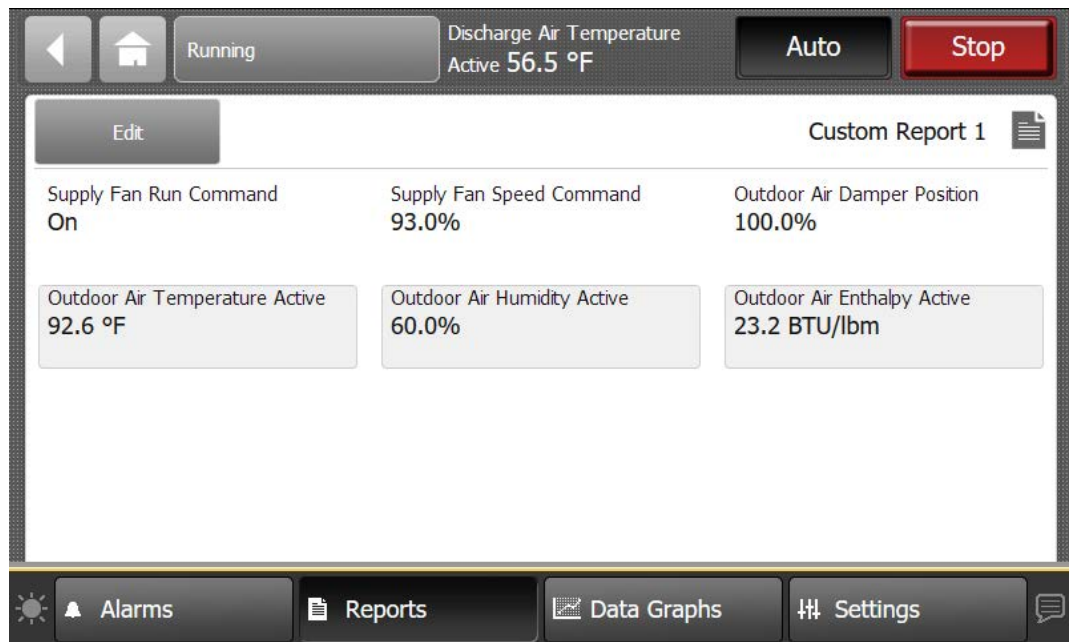



## Editing a Custom Report

1. Touch **Reports** to view the Reports screen.
2. Touch the report that you want to edit. Follow steps 2 through 5 in “Creating a Custom Report,” p. 31 to complete your edits.

**Figure 20. Editing a Custom Report**

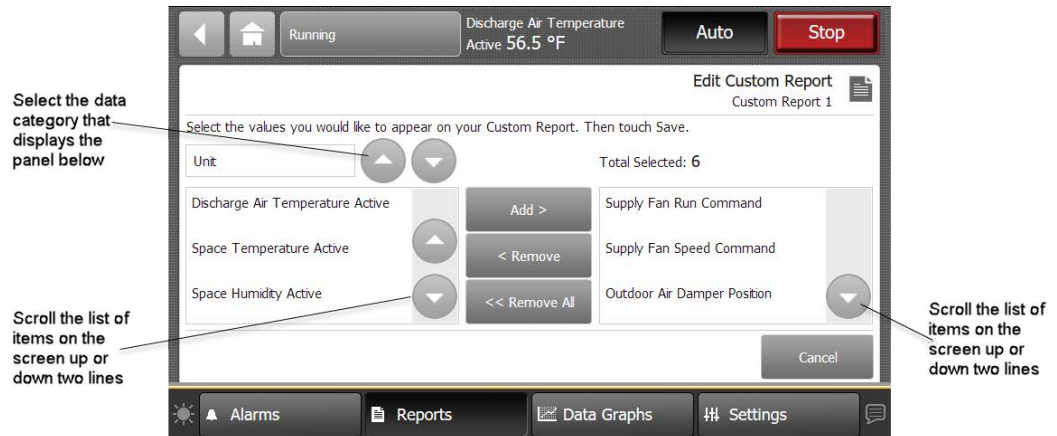

## Changing the Order of Items in a Custom Report

Items in a custom report can be rearranged according to personal preference by using the editing tools as described in Editing a Custom Report.

For example, you created the custom report shown in Figure 18, p. 32, but would prefer to move item “Supply Fan Speed Command” to the top left portion of the report.

**To change the order for the example described above:**

1. Touch the **Edit** button on the Custom Report screen.
2. Use the arrow buttons to locate the item to be reordered. When located, touch the item which will then be highlighted blue.
3. Use the arrow buttons to move the highlighted item to the top of the list (number 1 position).
4. Touch **Save**. You will be returned to the Custom Report screen, where the reordering changes now appear.

**Note:** On the TD7 display, report items are ordered from left to right with the first item appearing at the top left portion of the screen. Up to nine items can appear on each Custom Report screen with a maximum of 4 screens and 36 items per report.

The model in depicts a custom report screen with the first nine items displayed on the screen. Use this model to accurately reorder items in your custom reports.

**Figure 21. Custom Report (order of items)**

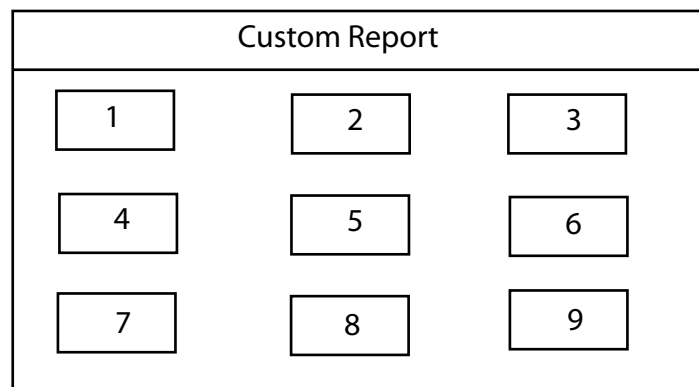

## Points

Touch the Points button to view the Points report screen, which contains access to screens for viewing and manipulating a subset of the BACnet® Point interface.

**Figure 22. Points reports screen**

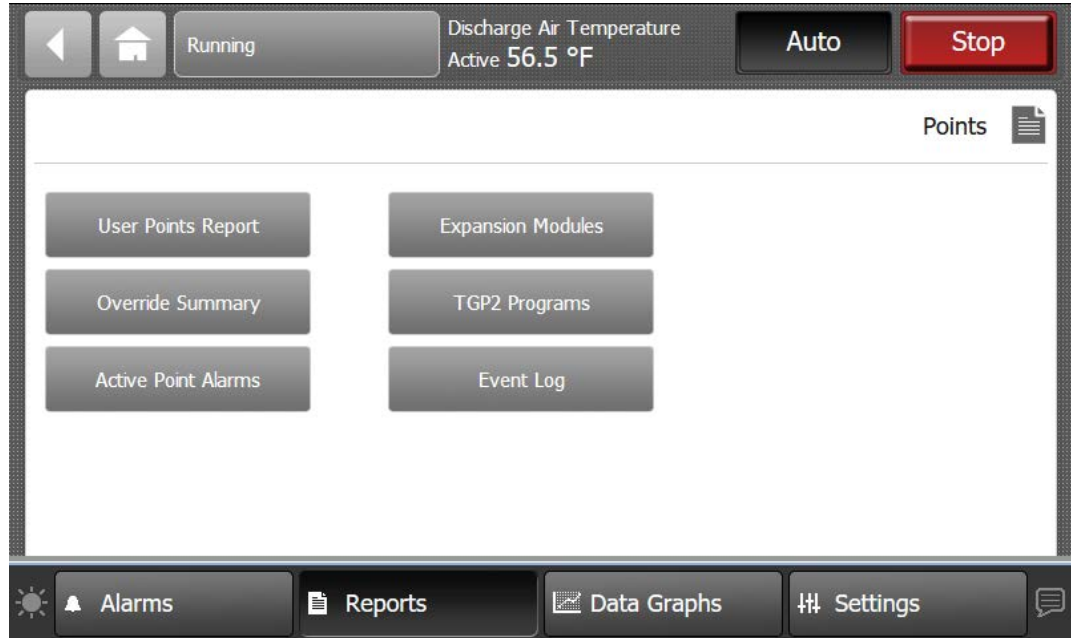

## User Points Report

Touch the **User Points Report** button to view the User Points Report screen, which contains user created points for the unit controller. Use the up and down arrows located at the right most bottom of the screen to page up or down.

**Figure 23. User Points Report screen**

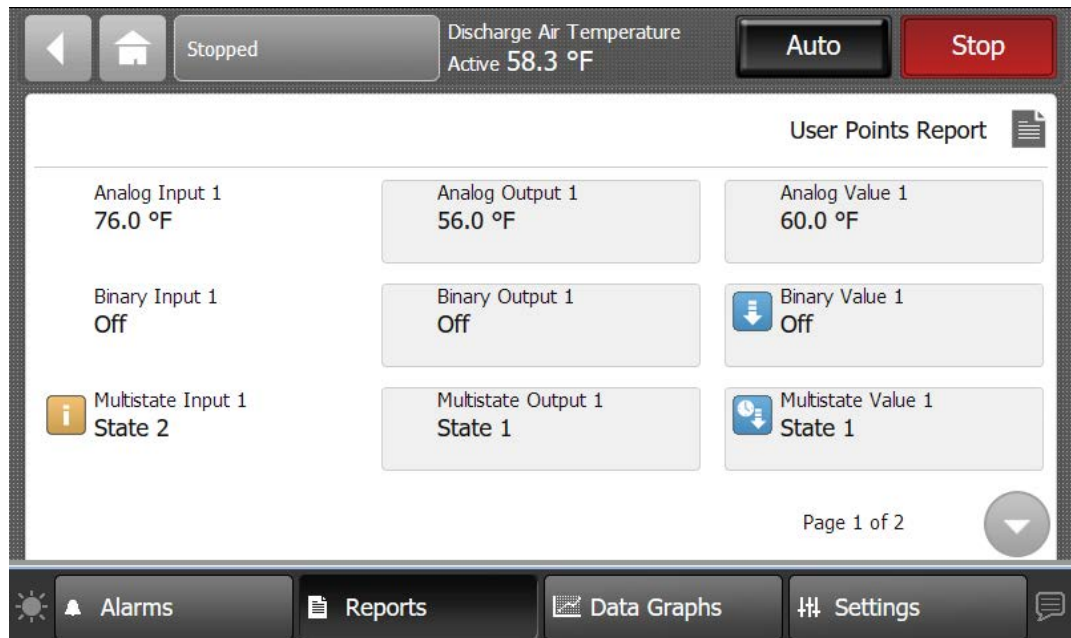

**Figure 24. Point Override screen components**

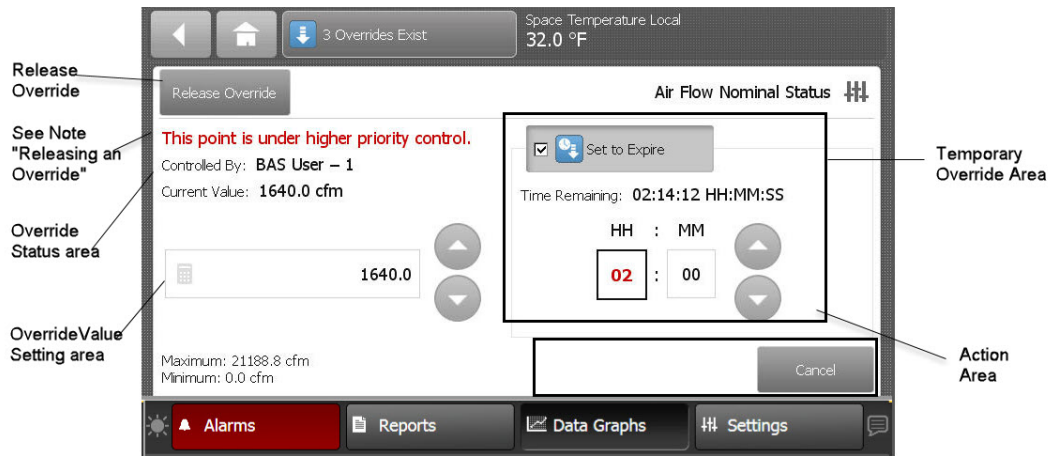

### Override Status Area

This area shows who is controlling the point, followed by the active priority level and the current value of the point. If security is enabled, the name of the user that performed the override will be shown in the Controlled By field. If security is disabled, "Front Panel" is displayed for all overrides performed by the TD7.

### Override Value Setting Area

This area contains buttons that when pressed, change the override status. The button that is active has a shaded appearance in color. The exception is analog points, which require manually entering a value.

### Temporary Override Area

This area allows you to set up a temporary override.

### Action Area

This area allows you to apply, save, or cancel edits made to the point override.

### Releasing an Override

Touch the Release Override button to release the current override. This action returns you to the Override Summary screen.

**Note:** *If a point is under a higher priority control, you can still proceed with releasing the override. However, it will not take effect until the higher priority level is removed in Tracer® TU, Tracer® SC+, or Tracer® Ensemble™.*

## Analog Overrides

The Analog Override screen contains up and down arrows in the Override setting area, as well as a keypad icon that when touched, opens the Analog Keypad.

Use the up and down arrow buttons to select a value. Touch the **Apply** or **Save** button to retain your changes. To manually enter a value, touch the keypad icon.

To display the Analog Keypad screen:

1. Touch the keypad icon to open the Analog Keypad screen.
2. Enter a value by tapping the numerals on the keypad.
3. Touch **Enter** to save and return to the Override screen.

**Figure 25. Display the Analog Keypad screen**

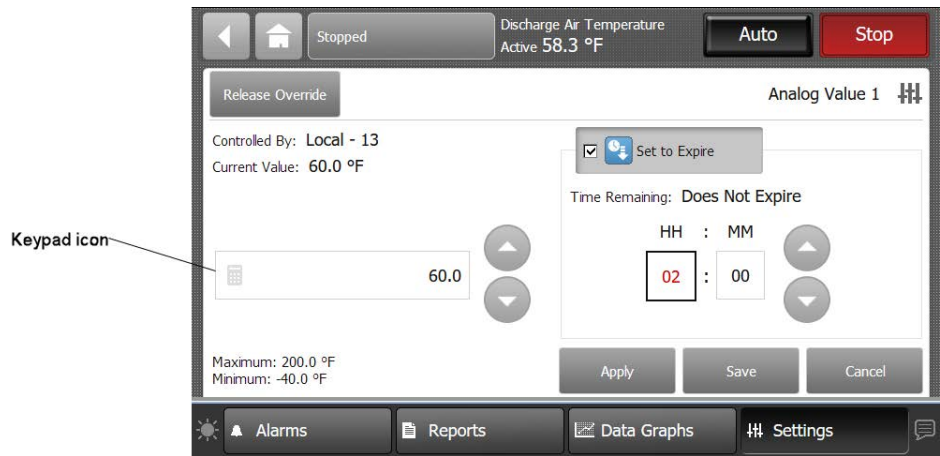

Analog Keypad screen

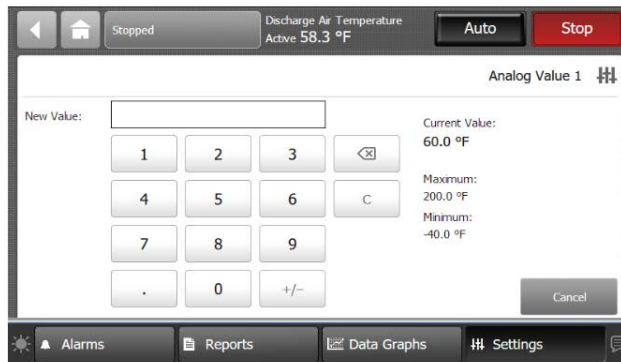

## Binary Overrides

The Binary Override screen provides buttons with point state text that is used to set the current value. Multistate overrides with four or fewer states have similar screen functions as the binary override screen.

Touch a button in the override setting area to select a state. Touch the **Apply** or **Save** button to retain your changes.

**Figure 26. Binary Override screen**

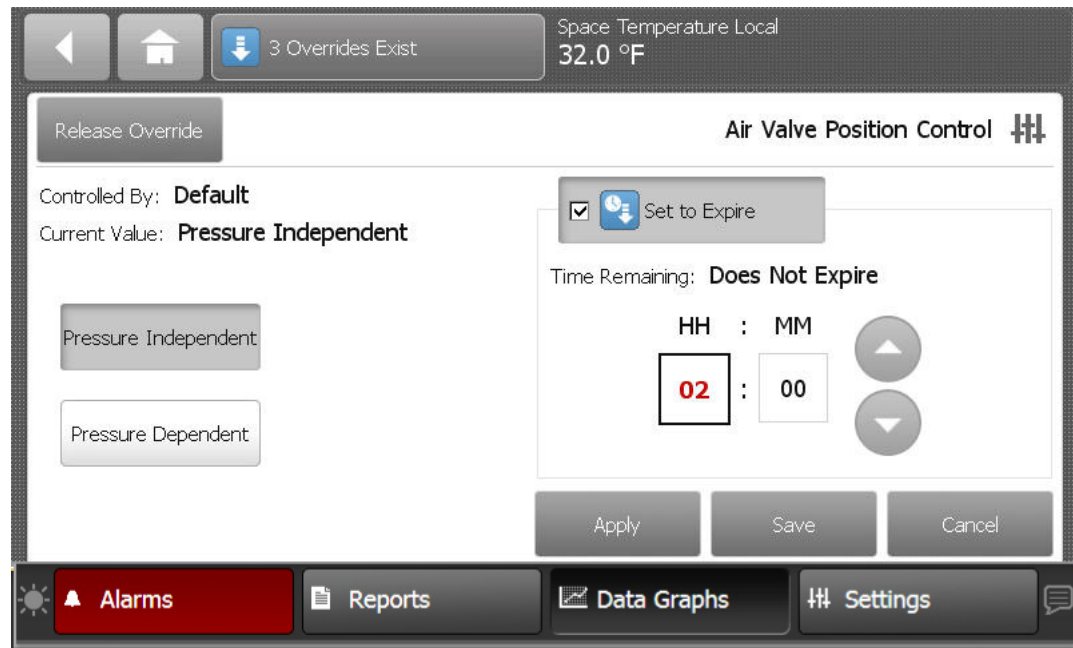

## Multistate Overrides

Multistate override screens that contain five or more items will contain up and down arrow buttons in the Override setting area.

Use the up and down arrow buttons to select a state. Touch the **Apply** or **Save** button to retain your changes.

**Figure 27. Multistate Override screen (five or more states)**

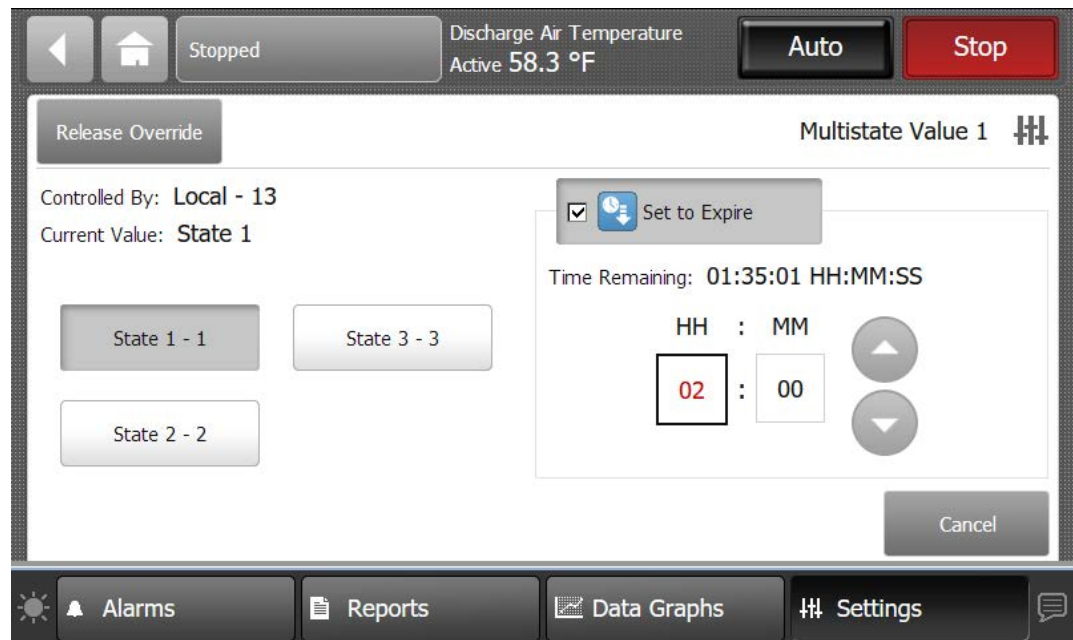

## Setting Up a Temporary Override

You can set up a temporary override by using the buttons in the Temporary Override area. The default duration for temporary overrides is 2 hours 0 minutes. The maximum duration for a

## Using the TD7 or TD12 Display

temporary override is 99 hours 59 minutes. If more time is needed, consider setting up a permanent override.

1. Touch the **Set to Expire** button.
2. check mark appears in the check box, the override icon becomes blue, and the Time Remaining area appears.
3. Touch either the hours (**HH**) or minutes (**MM**) button, then use the up and down arrows to set the override.  
The HH and MM buttons, when pressed change by one increment. Press down on the buttons to accelerate. A second touch of the (HH) or (MM) buttons will open the Analog keypad screen.
4. Touch the **Apply** or **Save** button to set the temporary override.

### Override Summary

The TD7 has a built in override summary report. Touch the Override Summary button on the Points screen.

The Override Summary screen contains all active overrides. Columns are sortable and automatically default to Time Remaining.

The override icon (📌) indicates that a point override is in effect indefinitely. The temporary override icon (🕒) indicates that an override will expire after a specified duration.

To release all overrides in the list, touch the **Release All Overrides** button (only points that are controlled at the TD7 user's priority level will be released). Touch anywhere in a point row to navigate to the corresponding Point Override screen.

**Figure 28. Override Summary screen**

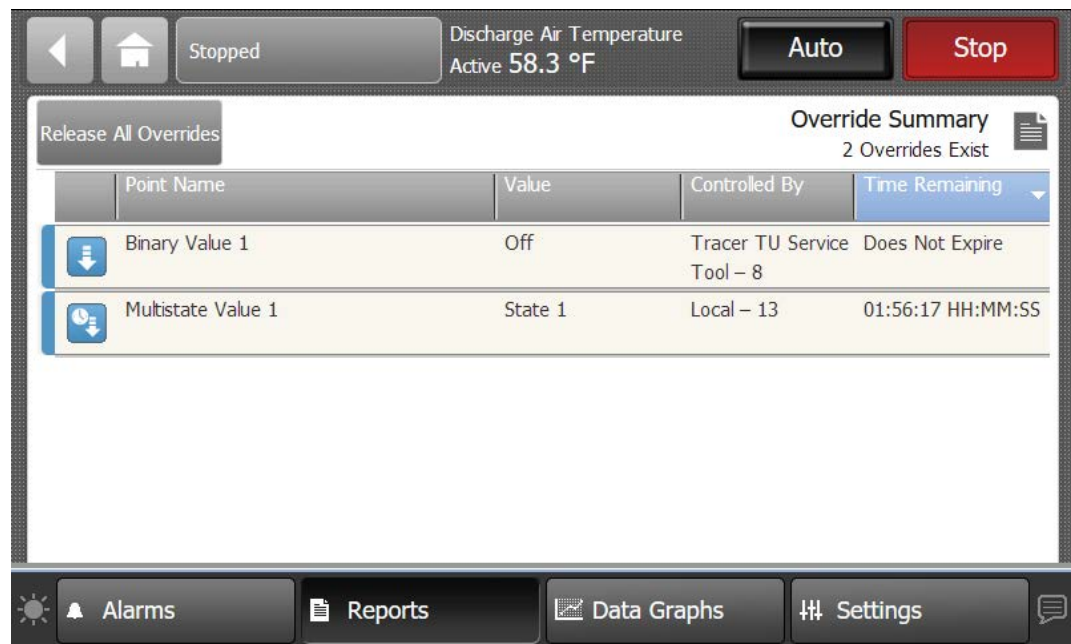

Point Name	Value	Controlled By	Time Remaining
Binary Value 1	Off	Tracer TU Service Tool - 8	Does Not Expire
Multistate Value 1	State 1	Local - 13	01:56:17 HH:MM:SS

## Active Points Alarms and Event Log

### Active Point Alarms

Active Point Alarms appear on the TD7 display immediately upon detection. Touch the Active Point Alarms to view the Active Point Alarms.

shows the Active Point Alarms screen and commonly used functions. When the point alarm clears and the point returns to normal, the alarm will automatically be removed from the list. The number of active point alarms is displayed in the top right portion of the screen.

For the point alarms to appear on the TD7 display, the point must have an alarm notification class selected other than None when it was set up in Symbio™ UI or Tracer® TU. Additionally, the point must have entered the appropriate notification (In Alarm, When Failed, Return to Normal, or the notification class set to a value other than None).

**Figure 29. Active Point Alarms screen**

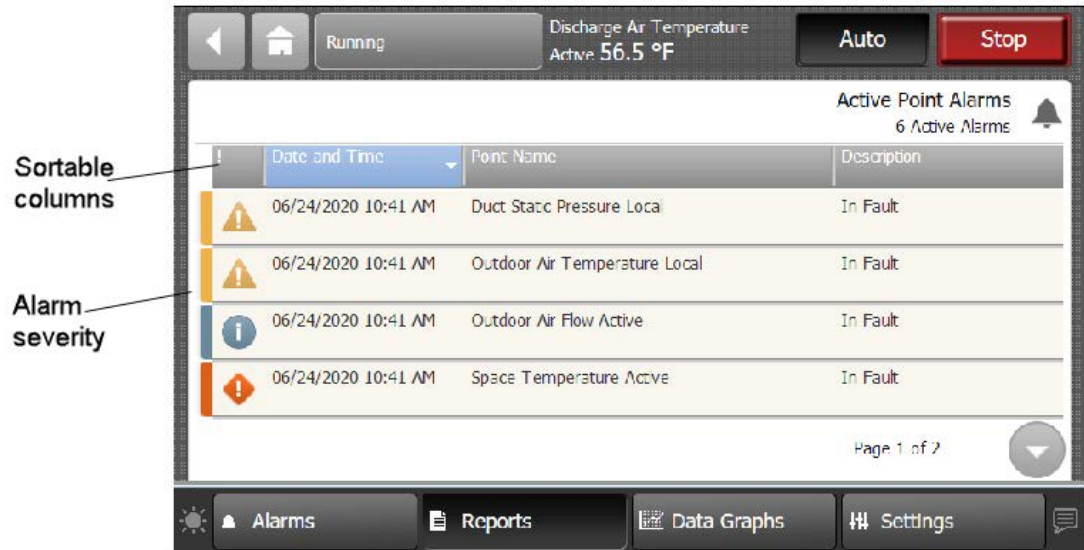

### Event Log

Touch the Event Log to view the Event Log.

Point Alarm icons appear in the left-most column of the Active Point alarms and Event Log screens. They are identifiable by their shape and color.

shows the Event Log screen and commonly used functions.

For the events to appear on the TD7 display, the point must have an alarm notification class selected other than None when it was set up in Symbio™ UI or Tracer® TU. Additionally, the point must have entered the appropriate notification (In Alarm, When Failed, Return to Normal, or the notification class set to a value other than None).



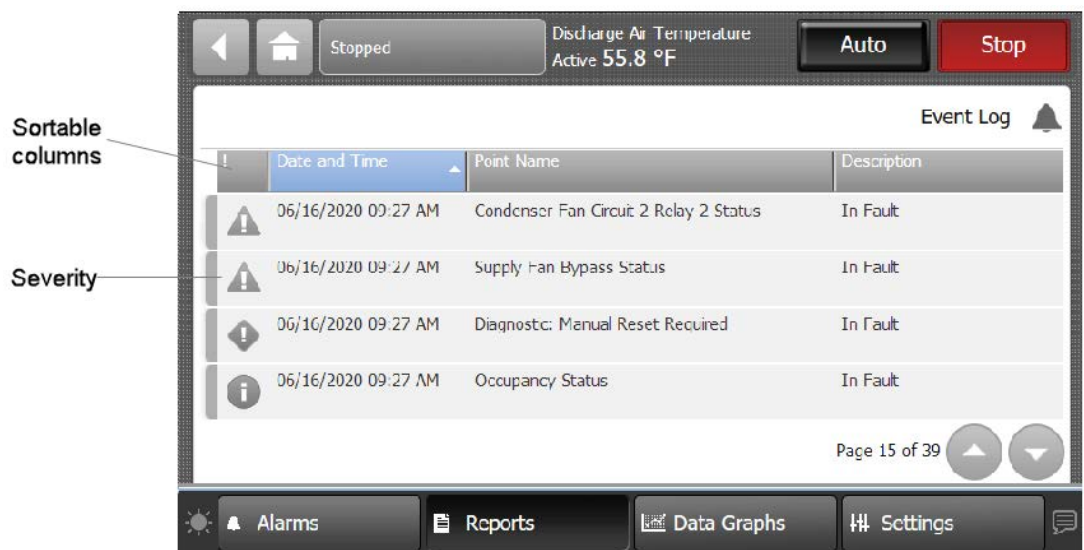







**Figure 30. Event Log screen**



### Point Alarm and Even Log Icons

Point Alarm icons appear in the left-most column of the Active Point alarms and Event Log screens. They are identifiable by their shape and color.

**Table 11. TD7 alarms**

Active Alarm	Historic Alarm	Severity
		Critical
		Service Required
		Warning
		Information
		None

### Sorting Point Alarms and Event Log Events

To sort point alarms or events in the event log by a category other than date and time, touch one of the other column headings in the table. The column heading responds by changing to blue, and the alarms table re-sorts according to the blue column heading. By touching the blue column heading again, the column will change the sort direction.

- Severity (!): Active alarms are at the top followed by the most severe.
- Date and Time (the default sort): Most recent alarms are at the top.
- Point Name: Alphabetical sort based on the point name.
- Description: Alarms are sorted alphabetically by description.

### Expansion Modules

Touch the **Expansion Module** button to view the Expansion Modules screen. If expansion modules have been installed, they will appear in Expansion Modules screen.



**Figure 31. Expansion Modules screen**

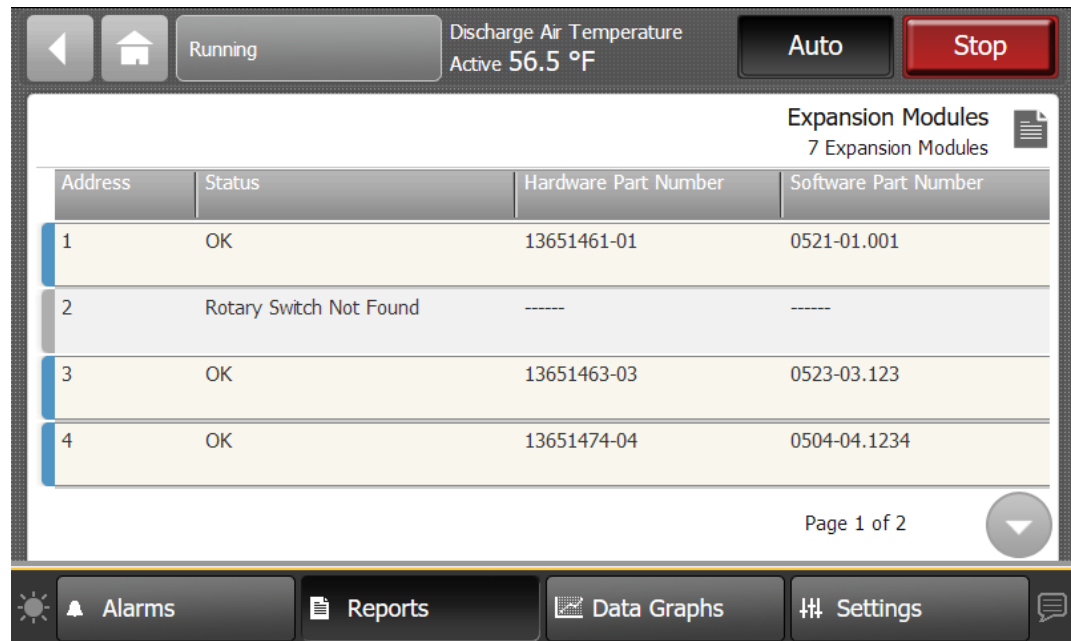

Expansion module screen columns:

**Address** — This is the rotary address of the defined or discovered expansion module.

**Status** — Under normal conditions, OK will display in this column. If not refer to "Tracer® XM30, XM32, XM70, and XM90 Expansion Modules IOM," BAS SVX46-EN.

**Hardware part number** — This is the part number for the expansion module.

**Software part number** — This is the version number of the software running in the expansion module.

## TGP2 Programs

Touch the **TGP2 Programs** button to view the TGP2 Programs screen. All TGP2 programs that have been installed on the controller appear here. The program name, status, run type, and interval for each program is provided. Interval is the scheduled run interval for the program and is displayed in HH:MM:SS. If the run type is Startup or Event, the interval field will display all zeros.

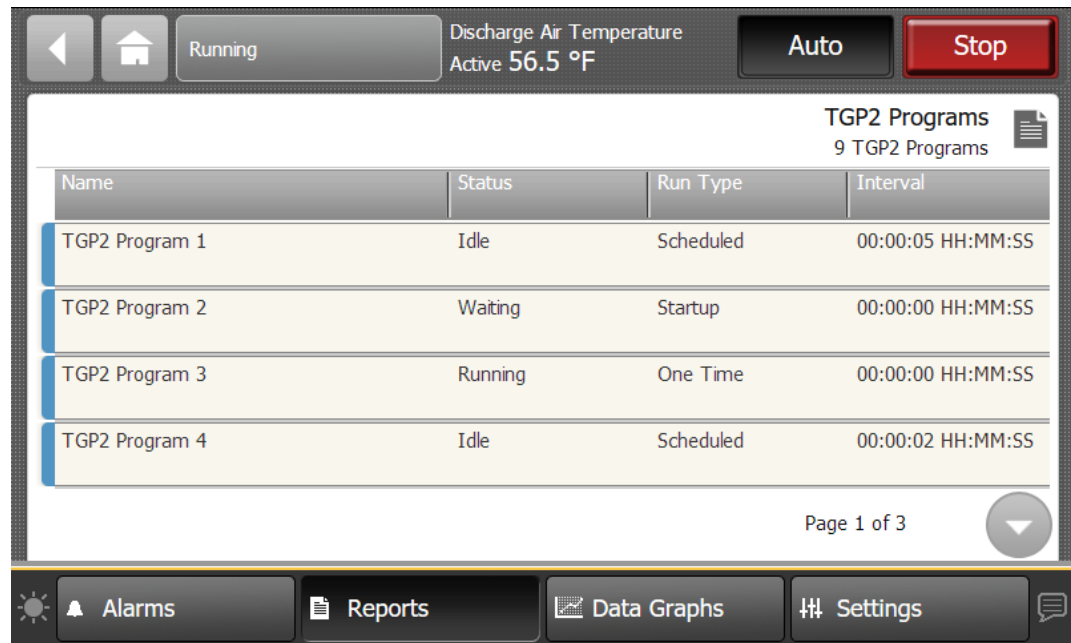
**Figure 32. TGP2 Programs screen**

## Unit

Touch the Unit button to view the Unit status information. The data presented in this table is unit configuration dependent, and is not shown in this document.

## Ventilation

Touch the Ventilation button to view Ventilation status information. The data presented in this table is unit configuration dependent, and is not shown in this document.

## Cooling

Touch the Cooling button to view Cooling, Circuit 1 and Circuit 2 level status information. The data presented in this table is unit configuration dependent, and is not shown in this document.

## Heating

Touch the Heating button to view Heating status information. These settings are unit dependent, and are not shown in this document.

## About

Touch the **About** button to view the About screen. View information about the unit controller and the TD7 display to which it is connected. Touch the arrow button to scroll to the next screen.

Figure 33. About screen

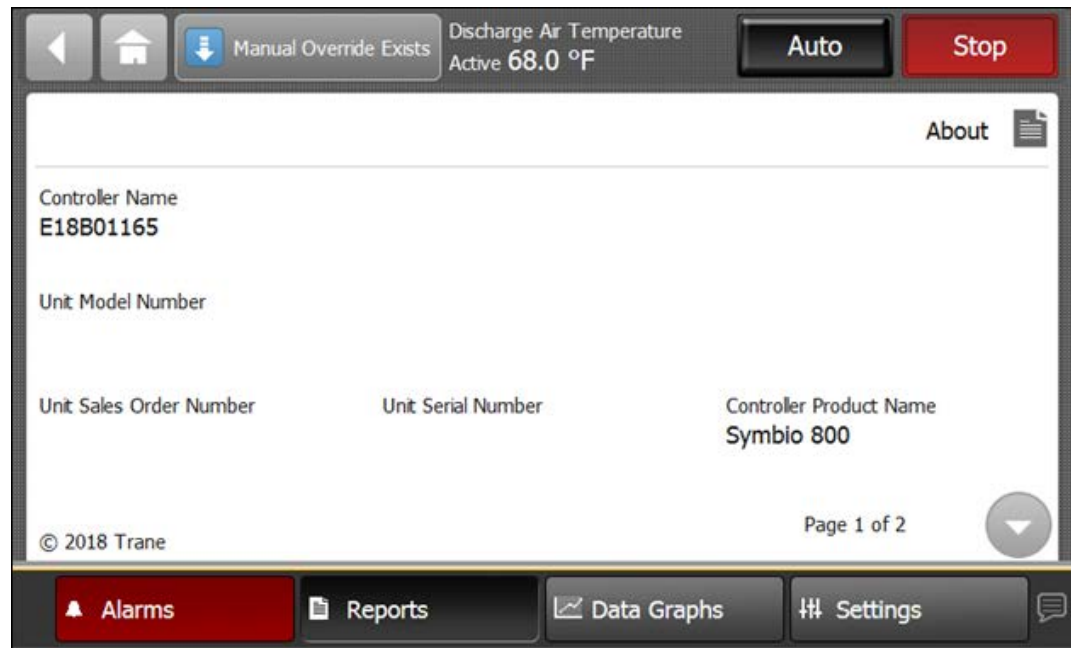

**Controller Name** — This is the name that was assigned to the Symbio™ 800. By default, the controller name is the controller serial number.

**Unit Model Number** — This is the model number of the IntelliPak™/equipment on which the Symbio™ 800 controller is installed. This value is typically entered in the factory, but can be entered in the controller.

**Unit Sales Order Number** — This is the order number for the equipment that the Symbio™ 800 controller is controlling. This number is typically entered at the factory, but can be entered in the controller.

**Unit Serial Number** — This number applies to the piece of equipment that the Symbio™ 800 controller is controlling. This number is typically entered at the factory, but can be entered in the controller.

**Controller Product Name** — The controller product name will always be Symbio™ 800.

**Controller Hardware Part Number** — This is the part number for the Symbio™ 800 controller.

## Operating Modes

### Data Graphs

Data graphs allow users to view trend logs from the controller in graphical format on the TD7 Display. Up to eight standard data graphs can be viewed. Custom graphs are user defined and can be edited by changing the scale on the left and right Y-axis and choosing the line color.

Touch the **Data Graphs** button in the bottom display area to view the Data Graphs screen. The Data Graphs screen contains eight buttons that allow you to view one of eight standard graphs. Some standard graphs may not exist for your unit.

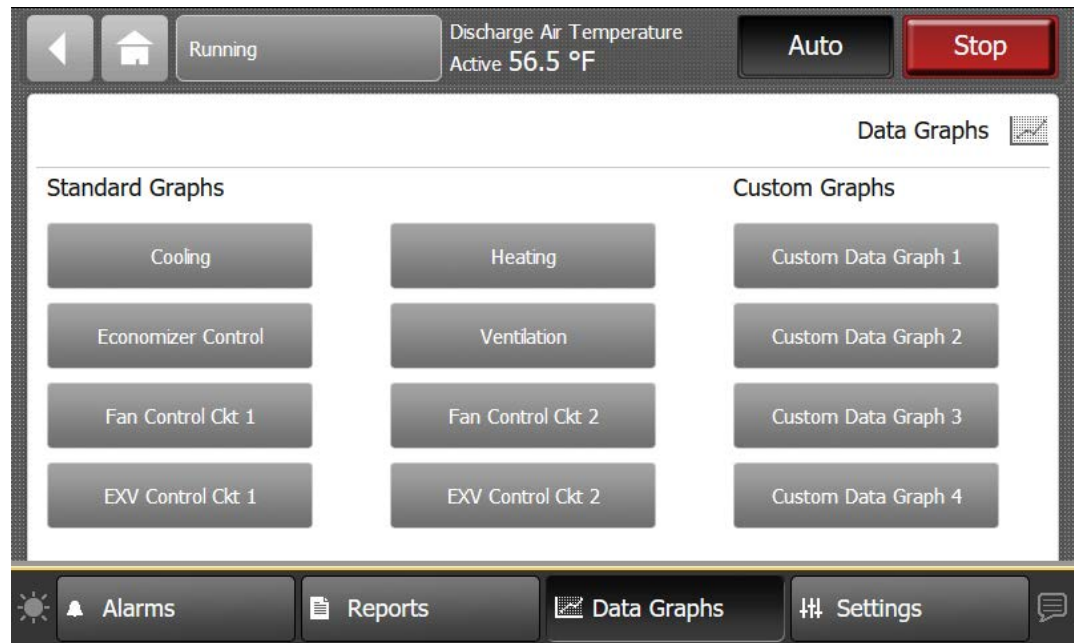
**Figure 34. Data Graphs screen**

### Viewing Standard Graphs

These graphs are predefined and not editable. Some graphs may not be displayed if the function is not supported by the unit configuration, for example: Heating.

### Creating a Custom Data Graph

1. Navigate to the Data Graphs screen, then touch one of the four Custom Data Graph buttons in the right column. The Custom Data Graph screen appears.
2. Touch the **Edit Data Graph** button.  
The Edit Data Graph screen appears.

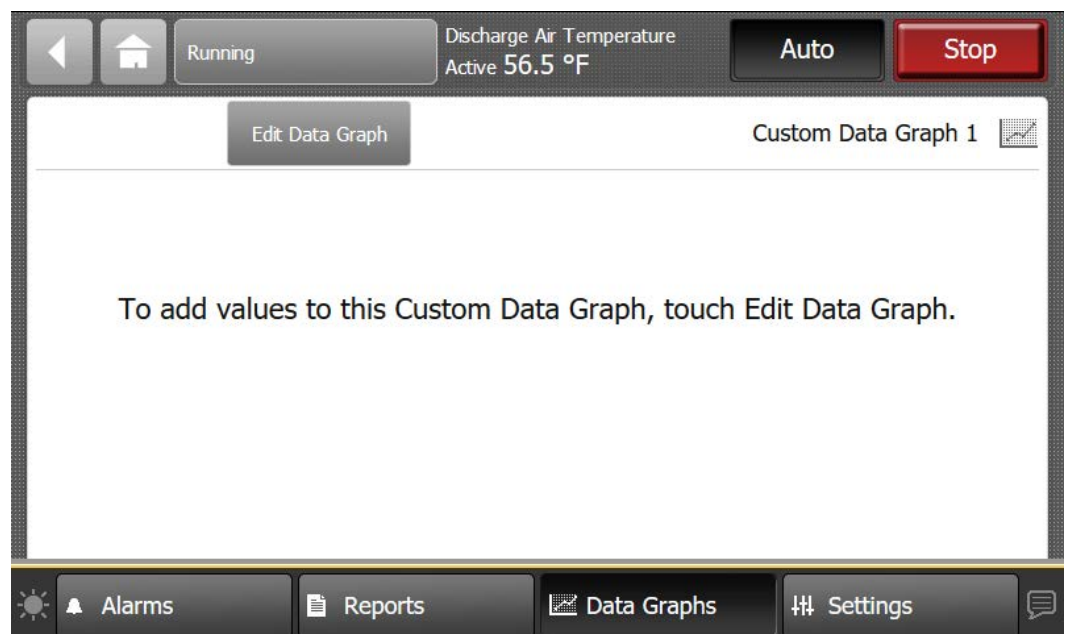
**Figure 35. Edit Data Graph screen**

3. Touch the **Add/Remove** button to add values to the custom data graph.  
The Add/Remove screen appears.
4. Use the arrow buttons to select a datalog type: analog, binary, or multistate, which then populates the box directly below.
5. Select the values, then touch the **Add** button (up to four selections are allowed).
6. Touch the **Save** button. The Edit Data Graph screen appears, which reflects the selected values.

**Figure 36. Adding data to the Custom Graph**

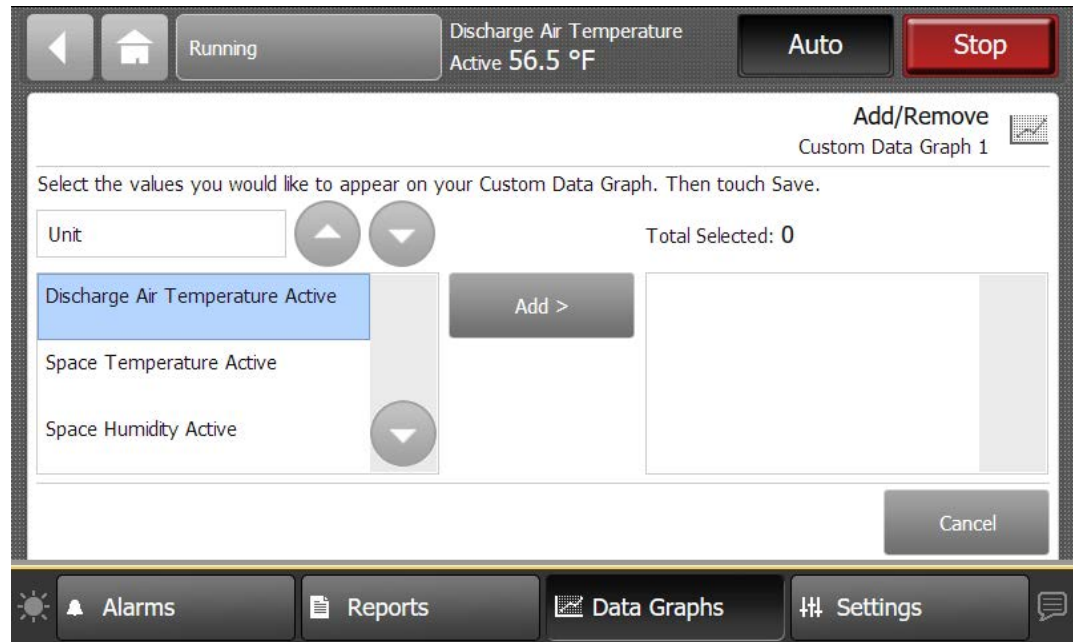

7. Use the Edit Data Graph screen to modify the data graph. Touch the **Edit** button that corresponds with the value that you want to change. Only one value can be edited at a time.

**Figure 37. Edit Data Graph screen (after values have been added)**

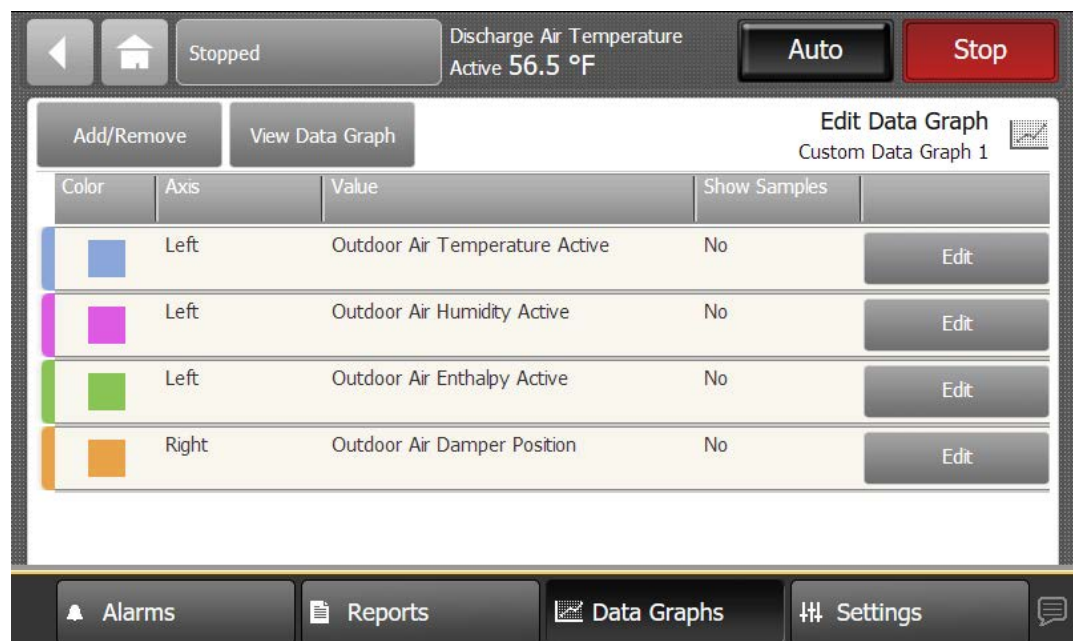

- From the Edit screen you can choose which Y-axis to display the value, a color, and whether or not to show data samples. Touch the **Save** button when finished. Repeat the process with remaining values.

**Figure 38. Customizing the data graph**

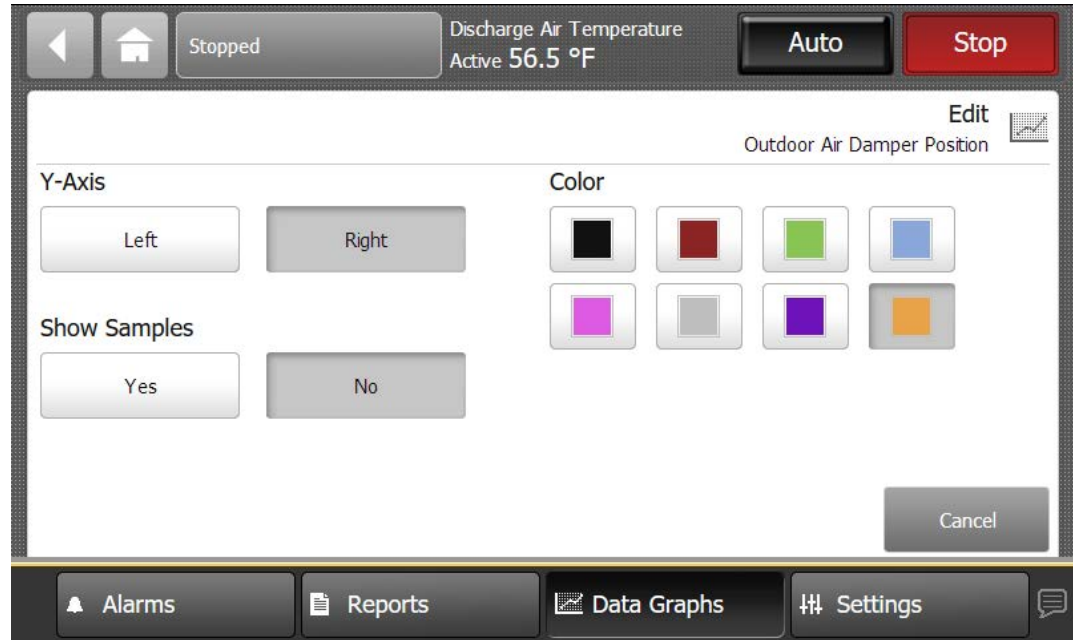

- Touch the **View Data Graph** button to display the new graph.

**Note:** Depending on the sampling rate, the custom data graph may be empty for several hours.

You can make changes to the way data is presented on the graph at anytime. Touch the zoom-in icon and zoom-out icon to either increase or decrease the viewable time frame. This action also enables back and forward arrows that allow you to view data at various times of the day.

**Figure 39. Viewing the data graph**

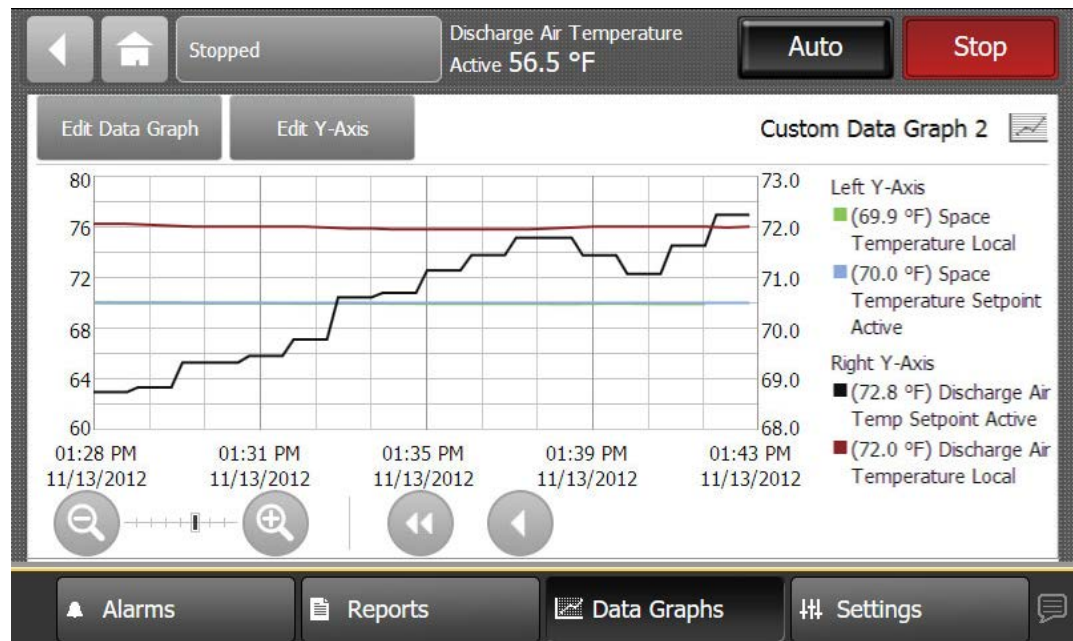

### Editing the Y-Axis

The default values on the right and left Y-axes can be changed according to your specifications.

1. Touch the **Edit Y-Axis** button located on the top portion of the Custom Data Graph screen.  
The Edit Y-Axis screen appears.
2. Touch the **Manually Select Range** box for either the left or right Y-axis.
3. Touch the **edit** button next to one of the two value ranges.  
The Keypad screen appears.
4. Select a new value and then touch **Enter** to save.
5. Repeat steps 2 through 4 until all preferred changes have been made.

**Figure 40. Editing the Y-Axis**

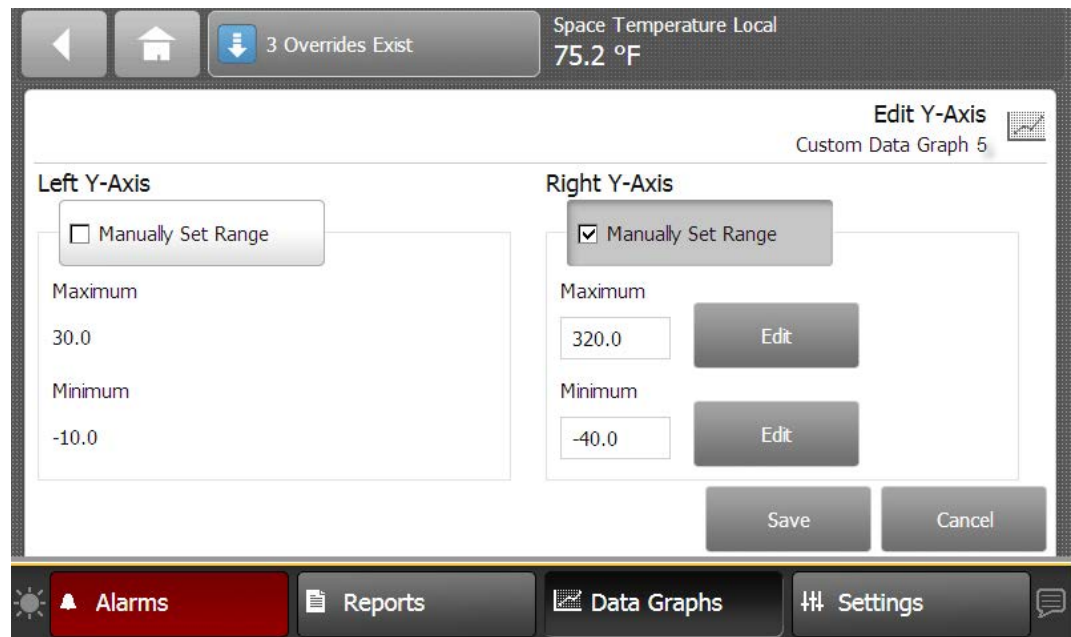

### Settings

The Settings screen provides options for display settings, language, overrides and security. Touch the **Settings** button in the bottom display area to view the Settings screen.

The data presented in the following tables is unit configuration dependent.

Three categories for settings appear on the screen:

- Equipment Settings
- Display Settings
- Controller Settings

**Figure 41. Settings screen**

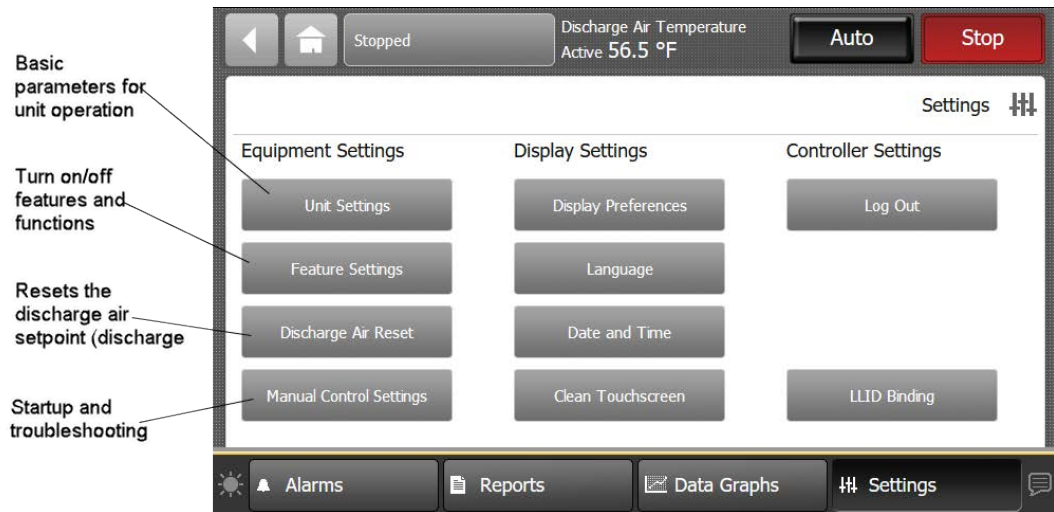

### Unit Settings

Unit Settings are the basic parameters for unit operation and provide the default values for setpoints and unit operating modes. These settings are unit-dependent and are not shown in this manual.

### Service Settings

Service Settings provides access to low level parameters required for all unit functionality. This information is unit dependent, and is not shown in this document.

## Supply Fan VFD Bypass

Supply Fan VFD Bypass (if configured) allows fan operation when the VFD is not available (Supply Fan Bypass mode operation is available whether a VFD is functional or not). This is accomplished by interacting with the **Supply Fan Bypass Mode Enabled** button on the TD7 Display located under **Settings – Unit Settings – Service Settings** screen. Refer to [Figure 42, p. 49](#). Whenever this bypass option is installed, the unit will include all of the necessary components and wiring to bypass the VFD assembly(s) and allow the supply fan(s) to operate in full airflow modes. Supply fan airflow proving/un-proving is important to insure the inertia of the fan has reduced enough to avoid potential fan direction reversal due to component miss-wiring. Please see the Intellipak™ IOM for details concerning airflow proving.



**Figure 42. Supply fan bypass mode enable button**

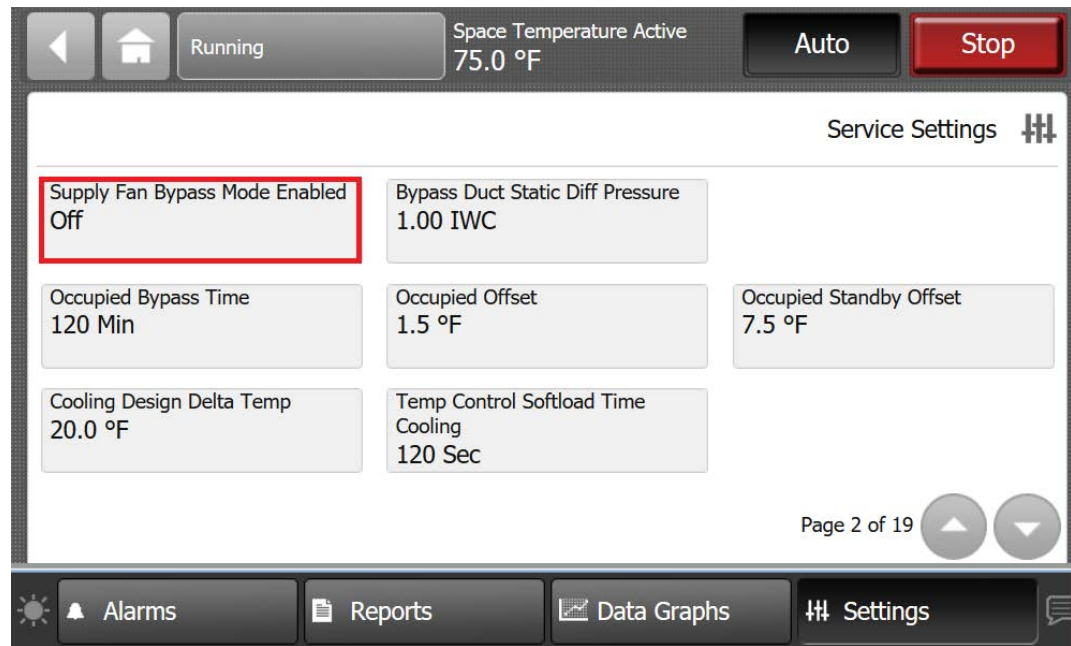

## Entering a Supply Fan VFD Bypass Event

- At all times when the unit is not in an active Supply Fan VFD Bypass Mode, the Supply Fan Bypass Relay will be commanded OFF (de-energized).
- The user will not be allowed to place the unit into an active Supply Fan VFD Bypass Mode at the TD7 Display until all of the following has occurred:
  - The user has requested Unit Stop Mode at the display.
  - All components have been commanded OFF or CLOSED.
  - The supply fan proving logic indicates a no-flow condition has existed for 40 continuous seconds.
- When the user places the unit into an active Supply Fan VFD Bypass Mode at the TD7 Display, all of the following will be enforced:
  - For Multi Zone VAV units the VAV Box Relay will be commanded ON (energized) to indicate full airflow mode to the system, and the VAV Box Stroke Time will count down (active Ventilation Override Modes that have VAV Box Relay set to OFF have higher priority and the relay will be commanded OFF).
  - Although the user can request Unit Auto Mode from the display it will be pending, and the unit will keep all components OFF or CLOSED until the VAV Box Stroke Time has timed out.
  - On non-Multi Zone VAV units, once the unit has entered active Supply Fan Bypass Mode the supply fan(s) will be allowed to run once the user has requested Unit Auto Mode at the display.
- When the unit enters active supply fan operation, and supply fan proving is satisfied, the unit will run in constant volume supply fan mode.
- During active bypass mode the unit's supply fan logic will turn the Supply Fan Bypass Relay On and Off to run or stop the fan(s).

## Exiting a Supply Fan VFD Bypass Event

- The user will not be allowed to remove the unit from an active Supply Fan VFD Bypass Mode at the TD7 Display until all of the following has occurred:
  - The user has requested Unit Stop Mode at the display.



## Using the TD7 or TD12 Display

- All components have been commanded OFF or CLOSED.
- The supply fan proving logic indicates a no-flow condition has existed for 40 continuous seconds.
- When the user removes the unit from active Supply Fan VFD Bypass Mode at the display, all of the following will be enforced:
  - The Supply Fan Bypass Relay will remain OFF.
  - For Multi Zone – VAV units the VAV Box Relay will be commanded OFF (de-energized) to indicate normal airflow mode to the system, and the VAV Box Stroke Time will count down.
  - Once the above conditions have been satisfied the user will be allowed to request Unit Auto Mode at the display.
- At all times when the unit is not in an active Supply Fan VFD Bypass Mode, the Supply Fan Bypass Relay will be commanded OFF (de-energized).

## Ventilation Override (if configured)

Allows modification and locking of Ventilation Override Modes.

**Table 12. Ventilation override modes**

Value	Settings (Factory Default)	Description
VOM A Supply Fan	Off (Off, On)	Factory Default Settings - Unit Off
VOM A Supply Fan Speed	Min (Min, Max, Auto)	
VOM A Relief Fan/ Dampers	Off/Closed (Off/Closed, On/Open)	All components are commanded off and closed.
VOM A Outdoor Air Damper	Closed (Closed, Open)	
VOM A VAV Box Relay	De-energized (De-energized, Energized)	
VOM A Ventilation Override Relay	De-energized (De-energized, Energized)	
VOM A Lock	Not Locked (Not Locked, Locked)	VOM A has highest priority, will override B, C, D, and E.
VOM B Supply Fan	On (Off, On)	Factory Default Settings - Pressurize
VOM B Supply Fan Speed	Max (Min, Max, Auto)	
VOM B Relief Fan/ Dampers	Off/Closed (Off/Closed, On/Open)	Over pressurizes the space to prevent air infiltration from
VOM B Outdoor Air Damper	Open (Closed, Open)	outside the space.
VOM B VAV Box Relay	Energized (De-energized, Energized)	
VOM B Ventilation Override Relay	Energized (De-energized, Energized)	
VOM B Lock	Not Locked (Not Locked, Locked)	VOM B has higher priority than C, D, and E.
VOM C Supply Fan	Off (Off, On)	Factory Default Settings - Relief
VOM C Supply Fan Speed	Min (Min, Max, Auto)	
VOM C Relief Fan/ Dampers	On/Open (Off/Closed, On/Open)	Performs an exhaust function to remove air from the space.

**Table 12. Ventilation override modes (continued)**

Value	Settings (Factory Default)	Description
VOM C Outdoor Air Damper	Closed (Closed, Open)	
VOM C VAV Box Relay	De-energized (De-energized, Energized)	
VOM C Ventilation Override Relay	Energized (De-energized, Energized)	
VOM C Lock	Not Locked (Not Locked, Locked)	VOM C has higher priority than D, and E.
VOM D Supply Fan	On (Off, On)	Factory Default Settings - Purge
VOM D Supply Fan Speed	Max (Min, Max, Auto)	
VOM D Relief Fan/ Dampers	On/Open (Off/Closed, On/Open)	Exchanges the air in the space with fresh air.
VOM D Outdoor Air Damper	Open (Closed, Open)	
VOM D VAV Box Relay	Energized (De-energized, Energized)	
VOM D Ventilation Override Relay	Energized (De-energized, Energized)	
VOM D Lock	Not Locked (Not Locked, Locked)	VOM D has higher priority than E.
VOM E Supply Fan	On (Off, On)	Factory Default Settings - Purge w/ Discharge Air Pressure Control
VOM E Supply Fan Speed	Auto (Min, Max, Auto)	
VOM E Relief Fan/ Dampers	On/Open (Off/Closed, On/Open)	Exchanges the air in the space with fresh air while performing duct
VOM E Outdoor Air Damper	Open (Closed, Open)	static pressure control within a multizone application.
VOM E VAV Box Relay	Energized (De-energized, Energized)	
VOM E Ventilation Override Relay	Energized (De-energized, Energized)	
VOM E Lock	Not Locked (Not Locked, Locked)	VOM E has lowest priority.

## Arbitration Method

Allows selection of the active source of setpoints and settings:

- **Full Source** – Result of arbitration from external controls (For example: Tracer<sup>®</sup> SC+, TGP2, 3<sup>rd</sup> party system control).
- **Local Source** – Isolates unit setpoints, settings, and sensors to local wired or wireless sources. Removes Full Sources.
- **Default Source** – Isolates unit to TD7 Display setpoints and settings, and local sensors. Removes Local Source and Full Sources.

### Feature Settings

Feature Settings allows you to enable or disable features and functions. The list is unit-specific and is not shown in this document.

### Discharge Air Reset

This button allows edits to Discharge Air Cooling Reset and Discharge Air Heating Rest functions.

### Manual Control Settings

Manual control settings are temporary overrides that are used to setup and test equipment and features. Most components are placed into manual override only after the unit has been placed into **Stop** mode from the TD7 display. In stop mode certain components (supply fans, relief fans/dampers, outside air damper, etc.) are manually controlled while the rest of the unit is prevented from running. Pressing the **Auto** button allows normal ventilation and capacity control to run simultaneously with the manually overridden components. Heating and cooling capacity manual overrides must also be setup during stop mode but will only be started after the unit is placed into auto operation. This ensures all normal protections and ventilation requirements are being met.

Referring to . below, when a component is placed into manual override, a blue box with a white arrow indicator is shown at the top of the TD7 display. To determine which components are in manual override control, either press the indicator button from any TD7 screen, or navigate to the **Settings - Manual Control Settings** screen. Overridden components will display the same indicator.

The **Manual Overrides Time Remaining** indicates the remaining duration of the current set of manual override events. The duration time is adjustable between 1 and 78 hours (default is 1 hr), and is located at the display's screen **Settings - Unit Settings** menu button **Manual Overrides Timer Setpoint**. Each time a component is placed into manual override the override timer restarts. When the override timer times out, all existing manual overrides are terminated and the unit returns to the last mode of operation (Circuit and Compressor Lockouts will not be terminated when the Manual Overrides Timer times out).



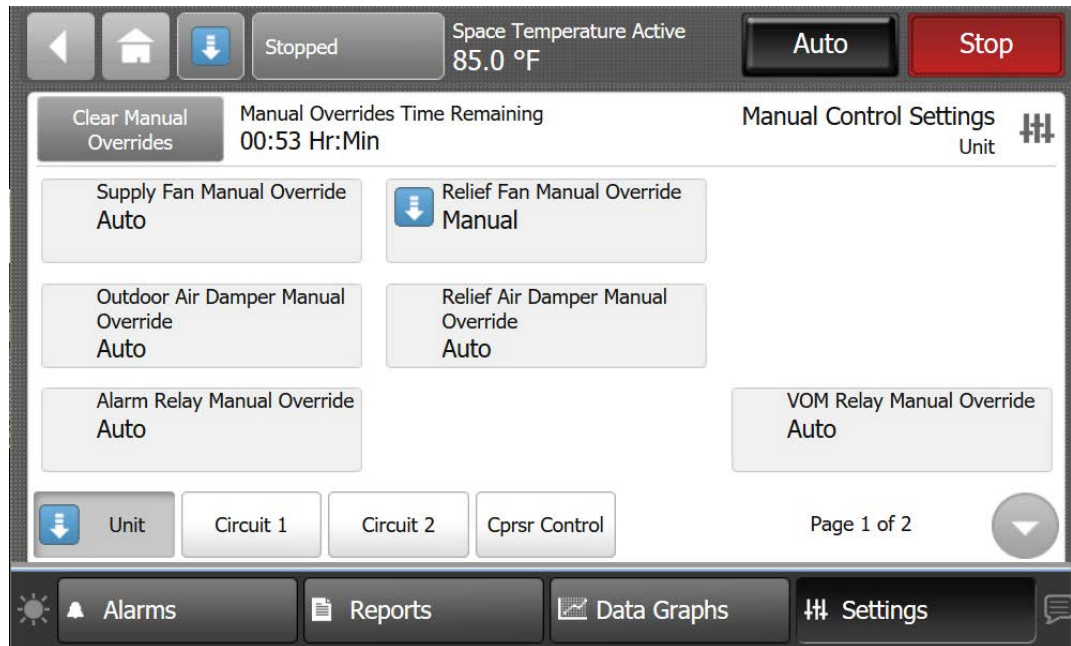











**Figure 43. Manual Control Settings screen**



The following tables list all the possible components that can be placed into manual control after selecting the **Unit**, **Circuit**, or **Compressor Control** button located at the bottom of the **Manual Control Settings** screen shown above.









Immediately following these tables there is an example of placing a component into manual override which is representative of the process for interacting with any of the components from this list.

**Table 13. Complete list of manual override selections – unit button**

Page 1					
	Supply Fan Manual Override Auto / Manual		Relief Fan Manual Override Auto / Manual		Return Fan Manual Override Auto / Manual
	Outdoor Air Damper Manual Override Auto / Manual		Relief Air Damper Manual Override Auto / Manual		
	Energy Consumption Reset XXXX kWh		Reheat Pumpout Relay Manual Override Auto / Manual		
Page 2					
	Alarm Relay Manual Override Auto / Off / On		VAV Box Relay Manual Override Auto / Off / On		VOM Relay Manual Override Auto / Off / On
	Gas Heat Modulating <sup>(a)</sup> Manual Override Auto / Manual		Gas Heat Staged Manual <sup>(a)</sup> Override Auto / Manual		
	Electric Heat Modulating <sup>(a)</sup> Manual Override Auto / Manual		Electric Heat Staged <sup>(a)</sup> Manual Override Auto / Manual		

<sup>(a)</sup> Manual Override Control of Heating outputs are setup in Stop mode, and will be turned On only in Auto mode.

**Table 14. Complete list of manual override selections – circuit 1 or circuit 2 button**

Page 1					
	Front Panel Lockout Ckt <sup>(a)</sup> Not Locked Out / Locked Out		Cond Air Flow Manual Override Cktx Auto / Manual		
	Front Panel Compressor Lockout CprsrA <sup>(a)</sup> Not Locked Out / Locked Out		Front Panel Compressor Lockout CprsrB <sup>(a)</sup> Not Locked Out / Locked Out		Front Panel Compressor Lockout CprsrC <sup>(a)</sup> Not Locked Out / Locked Out
	EXV Control Override <sup>(b)</sup> EvapxB Auto / Manual		EXV Control Override <sup>(b)</sup> EvapxB Auto / Manual		
Page 2					
	Condenser Reheat Manual Override Cktx Auto / Manual		Hot Gas Byp Valve Manual Override Cktx Auto / Manual		

<sup>(a)</sup> Circuit and Compressor Lockouts will not be terminated when the Manual Overrides Timer times out.

<sup>(b)</sup> EXV Control Overrides can be placed into active override during normal unit operation.

**Table 15. Complete list of manual override selections – cprsr control button**

Page 1					
	Compressor Control Manual <sup>(a)</sup> Override Auto / Manual				

**Table 15. Complete list of manual override selections – cprsr control button (continued)**

	Manual Enable Cprsr1A <sup>(b)</sup> Off / On		Manual Enable Cprsr2B <sup>(b)</sup> Off / On		Manual Enable Cprsr1B <sup>(b)</sup> Off / On
	Manual Enable Cprsr2A Off / On		Manual Enable Cprsr1B <sup>(b)</sup> Off / On		

(a) Compressor Control Manual Override must be set to Manual before compressors are placed in manual override.  
 (b) Manual Override Control of Compressors are setup in Stop mode, and will only be turned On in Auto mode.

## Beginning a Manual Override Event

**Note:** Please consider the following when applying manual overrides to the Supply and Relief fans. The **Fan Speed Command** value entered on these screens has a range of 0 to 100%. This commanded value range equates to Minimum Speed (min%) thru Maximum Speed (Hz or RPM) of the selected fan when the **Current Value** is **Manual**, and the fan is operating. The Speed Status shown is in percent where 0% equates to fan Off, (min%) equates to fan operating at minimum speed, and 100% equates to fan operating at maximum speed. See and . below for example fan motor commands and status.

**Table 16. Fan manual override command and status - example**

Fan Motor Speed Parameter	Min Speed Setup	Max Speed Setup	Fan Speed Command	Fan Minimum Speed (min %)	Fan Maximum Speed	Fan Speed Status
Hz	23 Hz <sup>(a)</sup>	60 Hz <sup>(a)</sup>	0%	38.30%	100%	38.30%
RPM	120 RPM <sup>(b)</sup>	1010 RPM <sup>(c)</sup>	65.40%	11.90%	100%	69.50%

(a) The Supply fan(s) motor’s minimum and maximum speed setup, in Hz, are entered via the VFD’s keypad.  
 (b) The Relief fan EBM motor’s minimum speed setup, in RPM, is set to 10% of motor nameplate speed and is not adjustable.  
 (c) The Relief Fan motor’s maximum speed setup is set to the RPM value entered at the TD7 display’s **Settings – Unit Settings – Service Settings** menu button for **Relief Fan Maximum Speed Setpoint**.

**Figure 44. Relief Fan Manual Override screen - example**

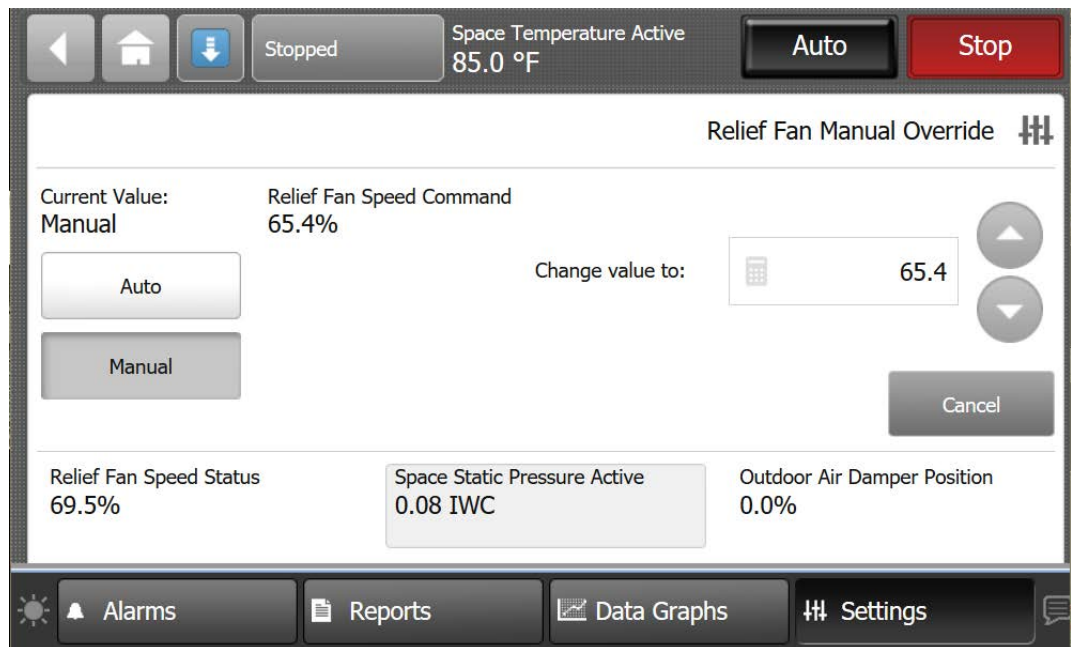

To begin a manual override event:

1. If necessary, press the **Stop** button on the TD7 display.

2. Press the **Settings** button.
3. Press the **Manual Control Settings** button.
4. Select the appropriate **Unit, Circuit, or Compressor Control** button.
5. Select the component to be overridden, then press the **Manual** button if shown.
6. Make the appropriate change to the component by turning it On/Off or changing its Speed/Position then press the **Enter** button.
7. Once returned to the **Manual Override** screen, press **Apply** or **Save** button to activate the manual override entry.

**Note:** The **Current Value** displayed should change from **Auto** to **Manual** when the **Save** or **Apply** button is pressed. If it reverts back to, or continues to display, **Auto** the manual override event did not activate. Make sure the unit has first been placed into **Stop** mode at the TD7 display. Some active entries may not start immediately due to protection delays or may not start at all if a unit protection feature is active.

### Terminating a Manual Override Event

To terminate an active manual override event, do one of the following:

- Allow the **Manual Override Timer** to time out.
- Navigate to the **Manual Control Settings** screen and press the **Clear Manual Overrides** button.
- Select an individual component that is in manual override and press the **Auto** button. Then press **Apply**.
- For manual override events that are active during **Auto** unit operation, press the **Stop** button at the TD7 display.

## Display Preference

Touch the **Display Preferences** button to open the associated screen. On this screen, all available options to display information on the TD7 screens are available. There are two pages on this screen, accessed by using the arrow button at the bottom of the screen.

**Figure 45. Display Preferences screen**

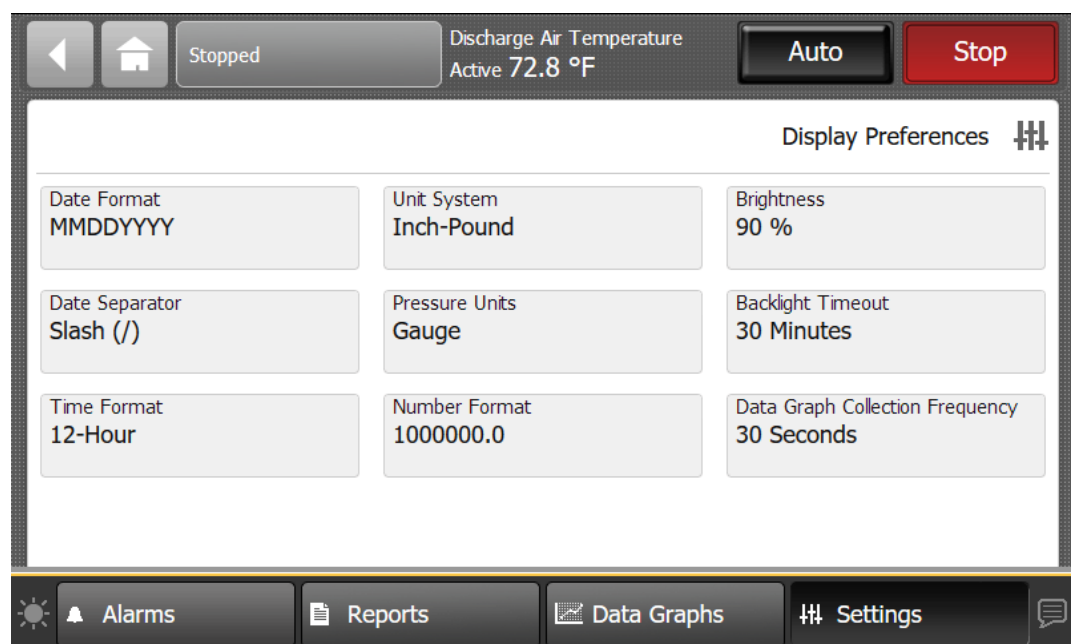

- **Date format** — Touch the **Date Format** button to open the associated screen. Three options are available to display the current date: MMDDYYYY, DDMMYYYY, and YYYYMMDD.

## Using the TD7 or TD12 Display

- **Date Separator** — Touch the **Data Separator** button to open the associated screen. Five options are available to display separators in the data format: None, Slash (/), Hyphen (-), Period (.), Underscore (\_).
- **Time Format** — Touch the **Time Format** button to open the associated screen. Two options are available: 12-Hour format and 24-Hour format (also referred to as “military time”).
- **Unit System** — Touch the **Unit System** button to open the associated screen. Two options are available: SI (system international) or Inch-Pound.
- **Pressure Units** — Touch the **Pressure Units** button to open the associated screen.
- **Number Format** — Touch the **Number Format** button to open the associated screen. Two options are available: period format (1000.0) or comma format (1000,0).
- **Brightness** — Use the keypad to enter a new brightness number.
- **Backlight Timeout** — Touch the **Backlight Timeout** button to open the associated screen. This value is measured in minutes, with 30 being the maximum limit. Use the keypad to enter a backlight timeout value. This value is the amount of time that the display will remain lit without activity. When the backlight times out, users will be automatically logged off due to inactivity.
- **Data Graph Collection Frequency** — Use the keypad to enter the frequency of data samples for the TD7 Data Graphs feature. The duration shown is maximum length of time the TD7 will be able graph.

**Figure 46. Home page screen**

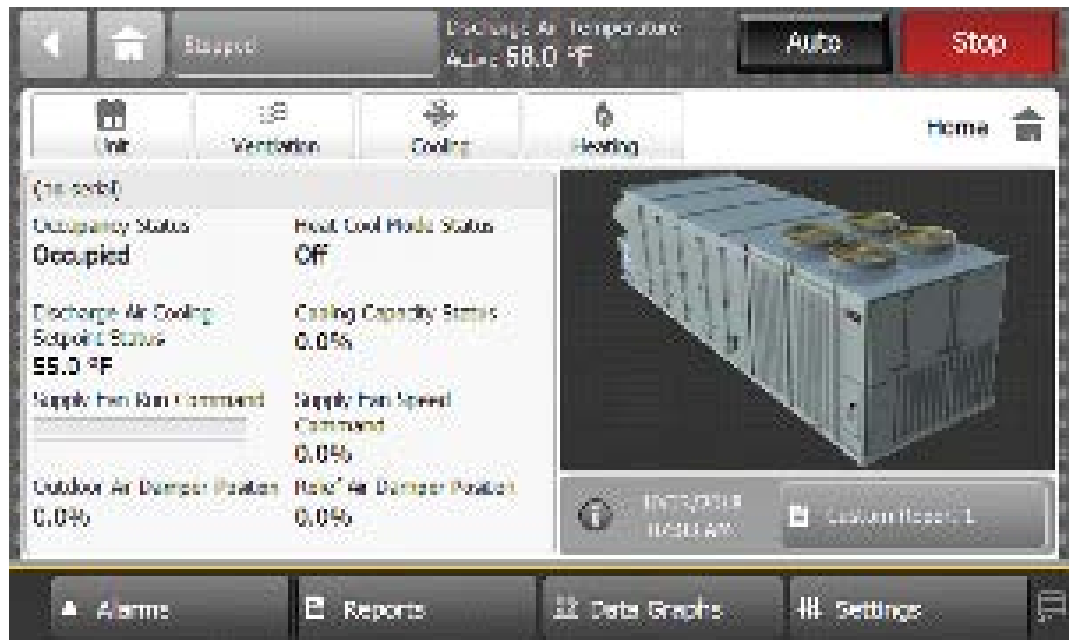

## Language

Touch the **Language** button, or the language icon located at the bottom right of each screen, to open the Language screen. Three languages are available and represented on the selection buttons. Select the language that you want displayed on each TD7 screen and then touch **Save**.



Figure 47. Language screen

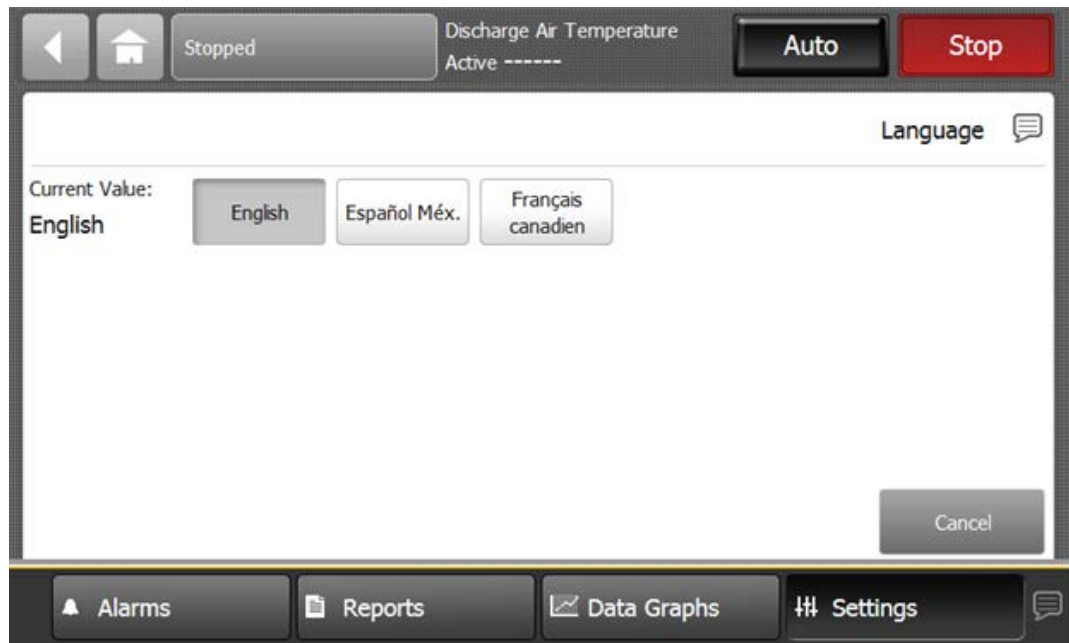

## Date and Time

Touch the **Date and Time** button to open the associated screen. To enter a new date or time, touch the digit you want to change. When enabled for editing, the digit will appear red with a black border. when finished, touch **Apply** or **Save**.

Or,

tap the digit twice which opens the keypad screen where you can make date and time entries. When finished, touch **Enter**; you will be returned to the Date and Time screen. Touch **Apply** or **Save**.

Figure 48. Date and Time screen

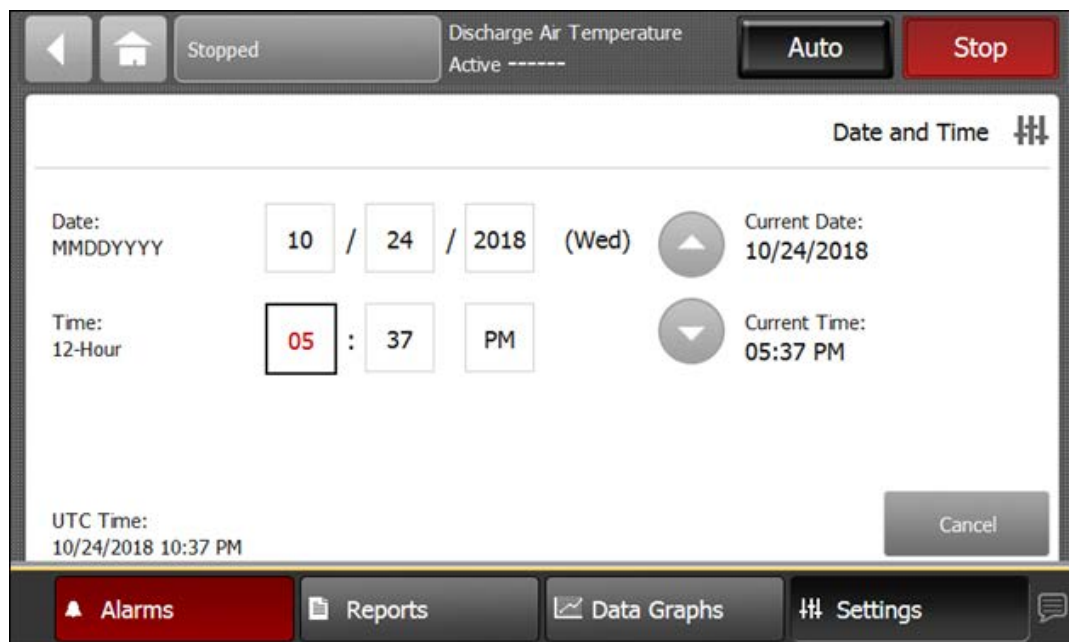

### Clean Touchscreen

Touch the **Clean Touchscreen** button to safely clean the TD7 touchscreen using any brand of common household glass cleaner. When this button is touched, the screen background color becomes black, allowing dirt and fingerprints to become more visible. It also displays a countdown timer (five to zero seconds). Touch the screen anytime within the 5-second countdown to begin cleaning the screen (each touch resets the 5-second countdown).

### Log Out

This button logs out the currently logged in user. Users are automatically logged out after 30 minutes of inactivity.

The button is only displayed when Security is enabled via Symbio™ UI.

### LLID Binding

This category contains the LLID Binding.

**Figure 49. LLID Binding**

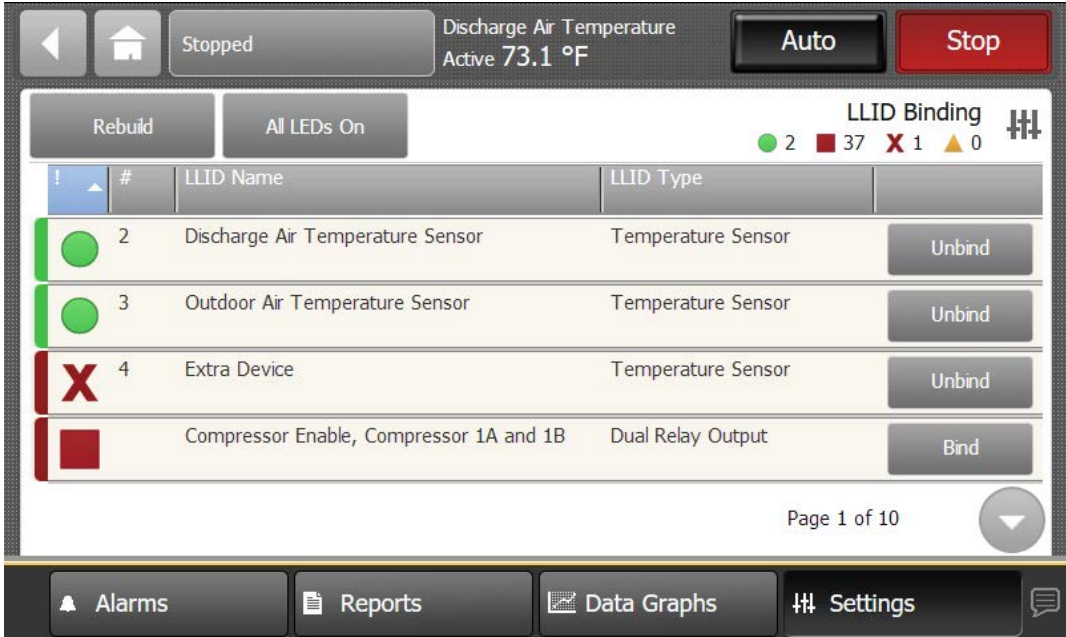

The screenshot displays the LLID Binding interface. At the top, there are navigation buttons (Back, Home) and a 'Stopped' status indicator. The main display area shows 'Discharge Air Temperature Active 73.1 °F' and control buttons for 'Auto' and 'Stop'. Below this, there are 'Rebuild' and 'All LEDs On' buttons. A summary for 'LLID Binding' shows 2 green circles, 37 red squares, 1 red X, and 0 yellow triangles. The main table lists the following LLID bindings:

!	#	LLID Name	LLID Type	
●	2	Discharge Air Temperature Sensor	Temperature Sensor	Unbind
●	3	Outdoor Air Temperature Sensor	Temperature Sensor	Unbind
✘	4	Extra Device	Temperature Sensor	Unbind
■		Compressor Enable, Compressor 1A and 1B	Dual Relay Output	Bind

At the bottom right of the table area, it says 'Page 1 of 10'. The bottom navigation bar includes 'Alarms', 'Reports', 'Data Graphs', 'Settings', and a chat icon.



# Symbio UI

Symbio UI is a term for web pages that are served up from the USB service tool port of the Symbio 800 at address 198.80.18.1 through an optional USB cable to the technician's laptop.

These pages are intended for general communication setup of the unit, and replace the need for a communication setup tool (BACnet setup tool for example). These pages are also available for general troubleshooting and unit setup (for example, alarm routing). This information should be used in conjunction with the TD display and Tracer TU (for the advanced service technician).

Generally speaking, the Symbio UI is not the source of information for day-to-day servicing. That task is better suited to the TD7 or TD12 display. Typically, the Symbio UI is used primarily during unit setup. However, the Symbio UI can be used by any technician at any time (security may be necessary if a secured login was setup by the installer).

Every unit type has slightly different information on the display. This document is written in a generic sense and cannot cover every possible type or example. However, the example shown in this section is from an Intellipak rooftop unit. The intent of this information applies to all unit types.

Programming Guides written specifically for the equipment will have greater detail.

## Connecting to the Symbio UI

Use Symbio™ UI to perform firmware updates, setup communication protocols, backup and restore, scheduling, and create users or custom trend views.

1. Connect a laptop to the USB service tool port using a USB 2.0 A to B cable.
2. Open a web browser and connect to <http://198.80.18.1> to access Symbio™ UI.

**Figure 50. Symbio UI connection**

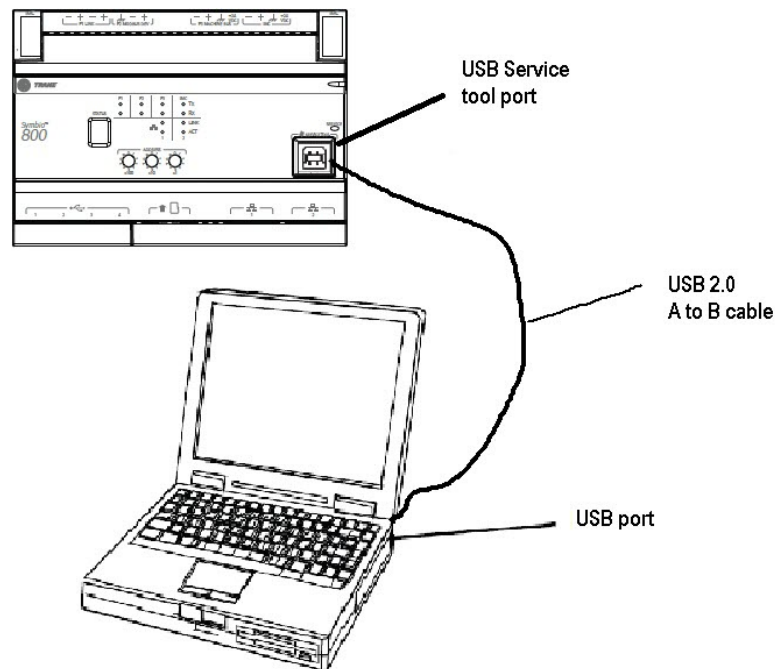

## Supported Browsers

Microsoft Windows 10:

- Internet Explorer 11 (no support)
- Microsoft Edge (most recent version)

- Mozilla Firefox (most recent version)
  - Google Chrome (most recent version)
- Apple Mac OS (latest version -1)
- Mozilla Firefox (most recent version)
  - Google Chrome (most recent version)
  - Safari (most recent version)

## Admin

An Admin button is provided on the top, global navigation bar for editing and creating Users, Roles, and setting Password Requirements.

### Creating a New User

***Note:** For more detailed instructions on creating a new user, click the help icon in the global navigation bar within Symbio™ UI.*

To create a new user:

1. From the global navigation bar, select Admin > **Users**.
2. Click the **Create User** button.
3. Enter the user's personal information, and click **Next**.
4. On the Preferences page, determine how certain attributes on the Symbio™ 800 user interface will display. Click **Next**.
5. On the Data Display Units Preference page, determine the unit type in which data will be displayed. Click **Next**.
6. On the Data Display Units Preference page, determine the preferred display units. Click **Next**.
7. On the summary page, review your selections. Click **Finish** to save the new user.

### Assigning Roles to Users

1. From the global navigation bar, select Admin > **Users**.
2. Click the role name to open and review details about the role.
3. To assign a role to a user(s), click the box to the left of the user name, then click **Actions... > Change Role**.
4. Using the pull down menu select a new role for the user, then click **Change Role**.

### Creating a New Role

1. From the global navigation bar, select Admin > **Roles**.
2. Click the role name to review details about existing roles. Click the **Create Role** button to create a new role.
3. Enter role information including Role Name, Description, Base Role, and Maximum Override Priority, and click **Next**.
  - a. **Base Role** selection is the starting point for creating a new role.
4. For the **Equipment Permission**, specify the Permission Granted for working with Points. Points are the interface used for BACnet®, MODBUS®, and LonTalk® communication. Click **Next**.
5. **Application Permissions** page provides the ability to customize the new role. When finished, click **Next**.
6. **Function Access** page allow selections the performing Backup, Installation and service, Restore, Audit log. When finished, click **Next**.
7. Use the **Summary** page to review full details of the new role. Click **Previous** to go back and edit selections for new role. Click **Finish** when ready to save the new role. Click **Cancel** to discard role and settings.

## Setting Password Requirements

To set password requirements:

1. From the global navigation bar, select Admin > **Security**.
2. Set password requirements:
  - **Password Requires Mixed Case** — Must contain at least one lower case or upper case letter.
  - **Password Requires Number** — Must contain at least one number.
  - **Password Requires Symbol** — Must contain at least one symbol such as %, \$, #, @.
  - **Password May Not Contain User Information** — Cannot contain the user ID name.
  - **Password Minimum Length** — The minimum number of required characters is 6. Use the spinner box to select a number.
  - **Number of Previous Passwords Blocked From Reuse** — Users are prohibited from creating a new password by reusing their most previous password. This can be extended beyond the most previous for heightened security. The valid range is 1 to 75. Use the spinner box to select a number.
  - **Enforce Password Expiration** — Select this check box to require users to create a new password when their current passwords expire.
  - **Days Until Expiration** — Use the spinner box to select the maximum number of days that passwords are valid until a new one must be created. Valid range is 7 to 365.

## Summary

In the Symbio™ UI, select **Applications > Summary**.

From the Summary screen, you can view the four categories of alarms along with the number of unacknowledged alarms for each.

- Advisory
- Critical
- Information
- Service Required

When Schedules are created they will be shown as well.

Click on the **Alarm Category** or **Schedule Name** to expand it for more information.

**Figure 51. Summary**

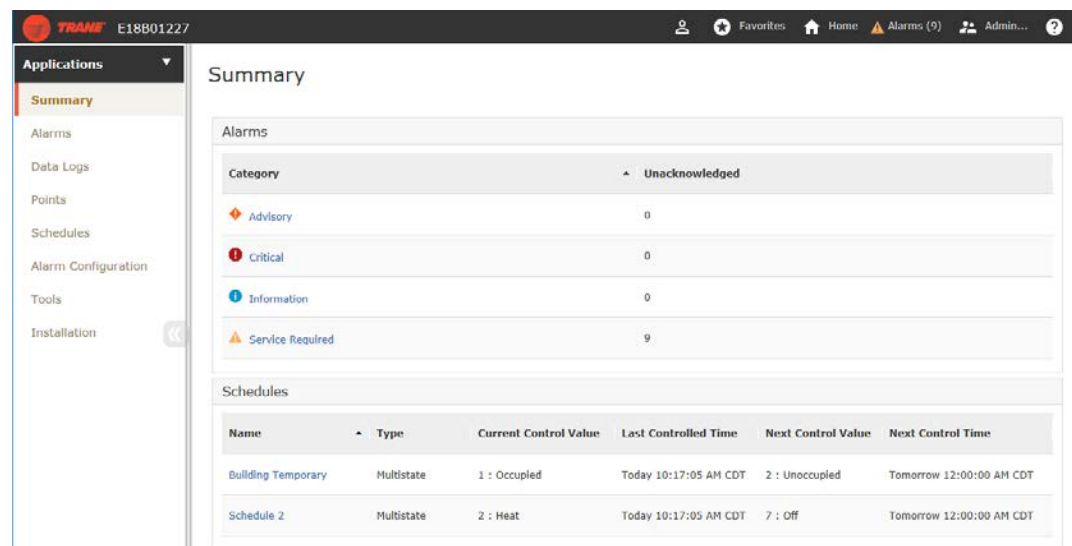

The screenshot shows the TRANE Symbio UI interface. The top navigation bar includes the TRANE logo, user ID 'E18801227', and navigation icons for Favorites, Home, Alarms (9), and Admin. The left sidebar shows the 'Applications' menu with 'Summary' selected. The main content area is titled 'Summary' and contains two sections: 'Alarms' and 'Schedules'.

**Alarms Summary:**

Category	Unacknowledged
Advisory	0
Critical	0
Information	0
Service Required	9

**Schedules Summary:**

Name	Type	Current Control Value	Last Controlled Time	Next Control Value	Next Control Time
Building Temporary	Multistate	1 : Occupied	Today 10:17:05 AM CDT	2 : Unoccupied	Tomorrow 12:00:00 AM CDT
Schedule 2	Multistate	2 : Heat	Today 10:17:05 AM CDT	7 : Off	Tomorrow 12:00:00 AM CDT

## Alarms

These alarms represent the BACnet® point alarms. BACnet® Alarms correlate closely to the “Active Point Alarms” within Reports from the TD7 display.

**Figure 52. Symbio UI™ Alarms screen**

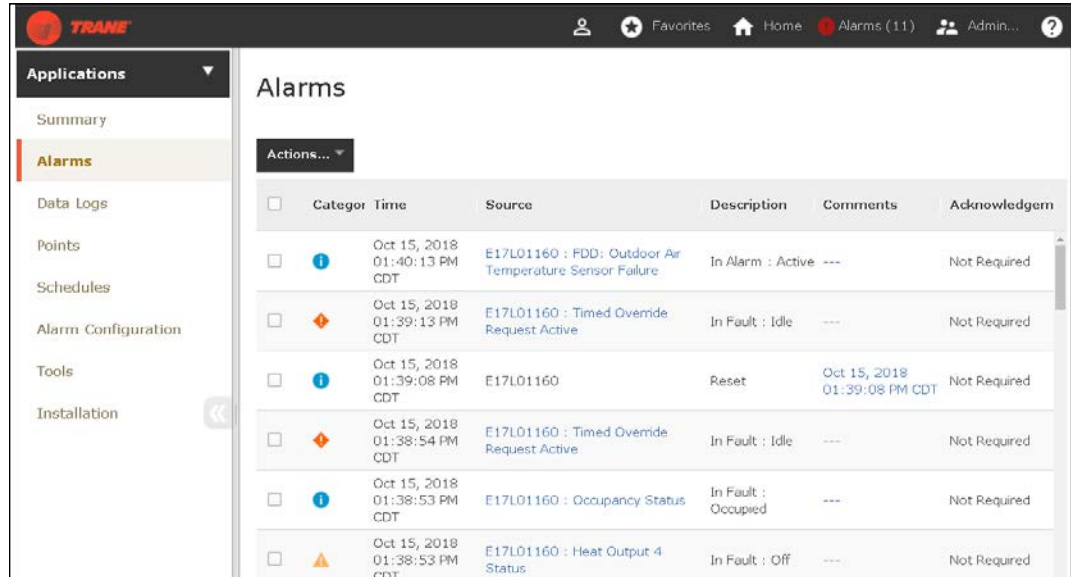

For the alarms to appear in this list, the point must have an alarm notification class selected. Additionally, the point must have entered the appropriate notification (In Alarm, When Failed, Return to Normal, or the notification class set to a value other than None).

## Alarm Icons

Alarm icons appear in the left-most column of the alarms screen. They are identifiable by their shape and color.

**Table 17. TD7 alarms**

Active Alarm	Notification Class
	Critical
	Service Required
	Warning
	Information
	None

**Note:** Notifications classes are configured in point alarm settings section in Tracer® TU.

## Sorting Alarms

To sort alarms by a category other than date and time, touch one of the other column headings in the table. The column heading responds by changing to blue, and the alarms table re-sorts

according to the blue column heading. By touching the blue column heading again, the column will change the sort direction.

- Severity (!): Active alarms are at the top, followed by the most severe, followed by the most recent.
- Date and Time (the default sort): Most recent alarms are at the top.
- Point Name: Alphabetical sort based on the point name.
- Description: Alarms are sorted alphabetically by description.

## Data Logs

Data Logging, also referred to as trending, records in real-time the value of a data point in the system and the time at which the value was recorded.

By default, Symbio™ 800 automatically generates system-created data logs (for equipment and standard applications) on a 15-minute interval and then stores that data for seven days. Data storage is a continuous window where only the most recent seven days of data are stored. Data older than seven days is discarded to make room for the newest data.

A list of data logs can be accessed by clicking **Data Logs** from the left navigation menu. From this page you can take action on a data log, such as comparing or exporting, by selecting one or more data logs and then clicking the **Actions** button.

**Figure 53. Symbio UI Data Logs**

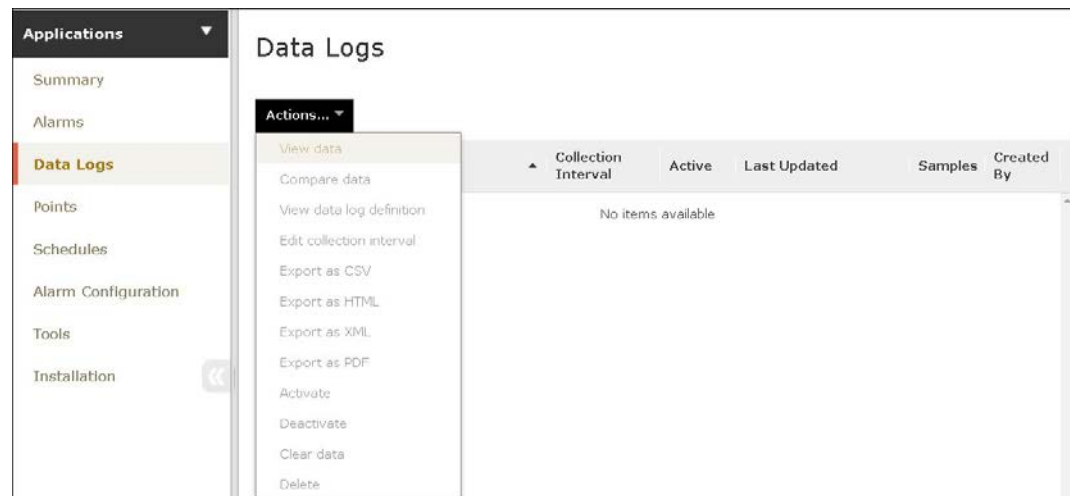

## Viewing Data Logs

To view Data logs graphically, select up to six data logs from the Data logs page and then select **View data** from the **Actions** button. The chart capability supports a time comparison mode that allows you to compare trend data at different points in time (day-to-day, month-to-month, year-to-year). A maximum of six data logs are supported (up to two data logs when time comparison mode is enabled). A maximum of two types of dimensionality are supported on the left and right y axis. Samples are plotted on a date/time scale on the x axis. Samples in fault (due to communication loss) are not plotted and will result in an interpolation gap within the plotted line. If all samples are in fault, no line will be displayed.

**Figure 54. Symbio UI Data Log**

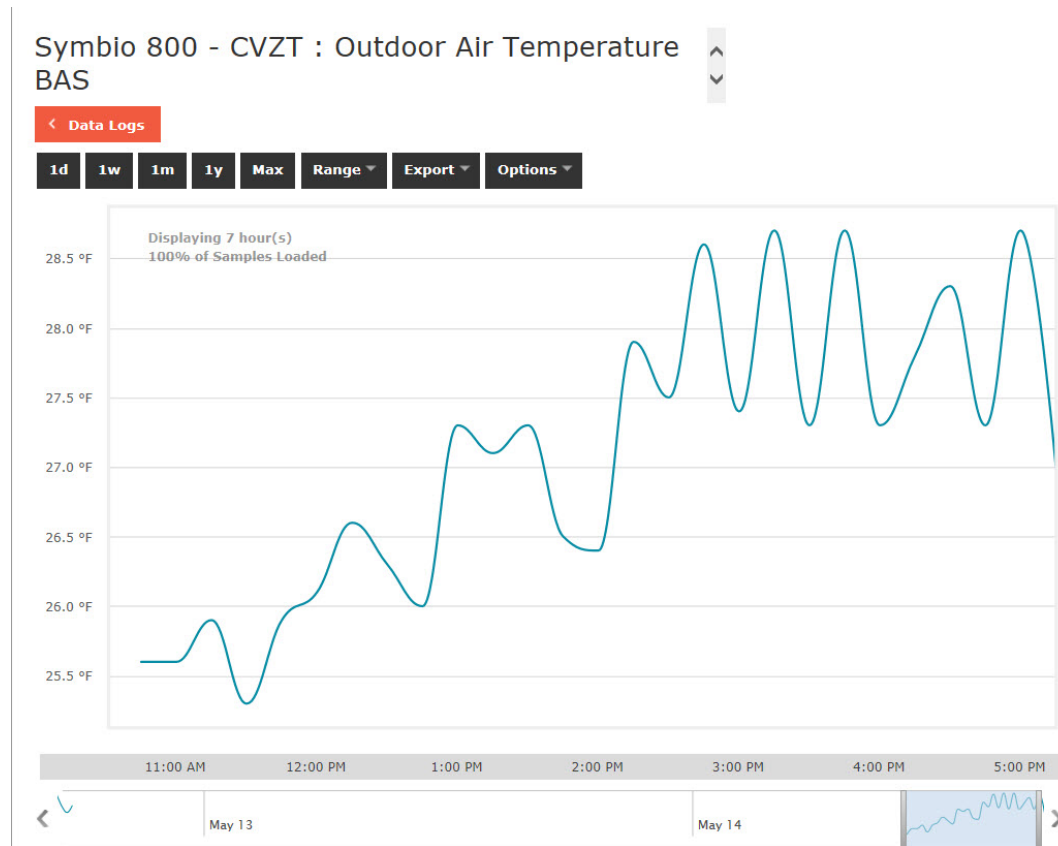

## Points

Points are how the controller communicates data and integrates into systems via standard protocols such as BACnet®, Modbus®, and LonTalk. Click left navigation pane **Points** to view all point types supported by the controller for the equipment it is configured. Points can be sorted by Name, Description or Value. Users with permissions can view details, configure, delete and recycle points from the controllers communication interface.

Viewing and editing point information:

1. Click left navigation pane **Points**.
2. Navigate by clicking **Analog Points**, **Binary Points** or **Multistate Points**.
3. Click on the point name to view and edit point details.



**Figure 55. Symbio™ UI Points**

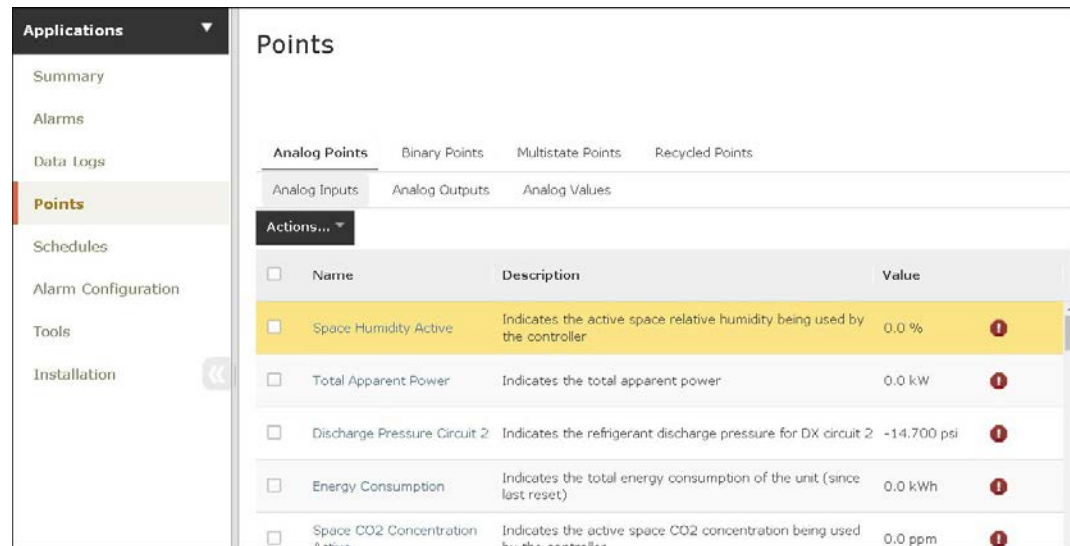

## Deleting Points

Deleting points is convenient for removing unwanted data from the controller communication interface. The point is not permanently deleted; rather the point is simply moved to **Recycled Points**.

All point overrides, priority array owners, and status are reset to factory settings.

To delete a point:

1. Click **Points** in left navigation pane.
2. Navigate to Analog, Binary, or Multistate points and select the point(s) using check box left of name.
3. Select **Actions** pull-down menu, then **Delete > Yes – Delete** to confirm the action. **No – Cancel** to cancel action.

## Recycled Points

Points that have been deleted from the controller interface are moved to Recycled Points. In this location the points can be restored to the controller interface and used once again to communicate data via BACnet®, Modbus®, or LonTalk.

To view recycled points and restore points:

## Creating a Data Log

1. Click **Points** in left navigation pane.
2. Navigate to Analog, Binary, or Multistate points and select the point(s) using check box left of name.
3. Select **Actions** pull-down menu, then **Log Data** and complete the settings.
4. Select Data Log Type and edit settings for the type.
  - **Data collection start on a schedule**, click **Next** to setup schedule information.
  - **Data collection starts on a trigger**, click **Next** to setup trigger information.
  - **Data collection starts now**, set buffering and data collection frequency, click **Finish** when complete.

## Points Override

Point overrides are used to allow control of values, such as setpoints used for the operation of the equipment. These can be time based or persist until they are released.

From the Point Override screen you can perform overrides, set them to expire in a user-defined interval, or release a point that is currently overridden. All Point Override screens, (analog, binary, or multistate), are comprised of the same basic components.

## Schedules

Scheduling is based on the BACnet® schedule object implementation. Scheduling is one of a facility’s most important energy-saving strategies. It ensures that equipment runs only when needed. Scheduling facilitates the following tasks:

- Creating, editing, and deleting schedules
- Creating, editing, and deleting calendars and exception schedules
- Viewing all effective schedules in a facility

The Schedules page contains four tabs: Active Schedules, All Schedules, All Exceptions, and All Calendars.

**Figure 56. Symbio™ UI Schedules**

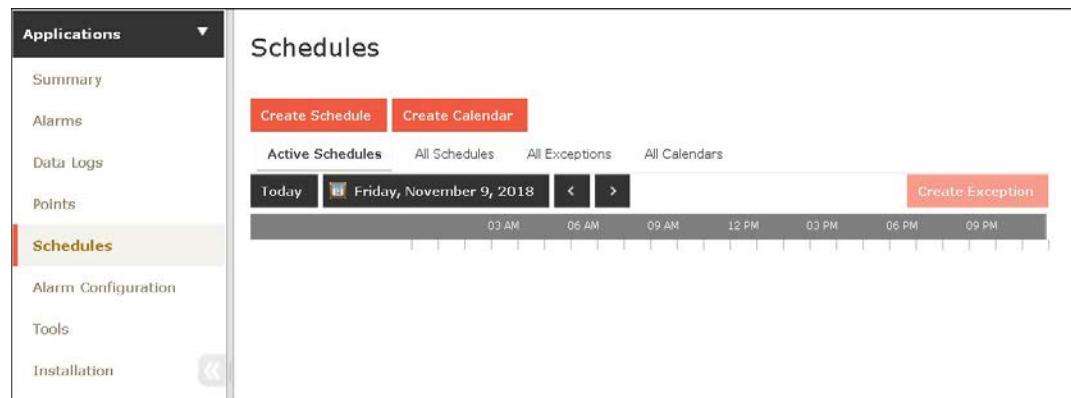

## Exceptions and Calendars

Exceptions are temporary modifications to a schedule. Exceptions contain one set of dates or one repeating pattern of dates. If a schedule has an exception applied, a red box outline will appear.

### Calendars

For multiple dates and repeating patterns a calendar can be created, which is then applied to the exception.

Calendars are used to group dates, which can then have exceptions applied to these dates on a schedule. For example, a school might create a calendar to group the days that require extended operating hours for after-school meetings.

### Release Function

The release function is a predetermined time in which the present schedule or the event releases control over to the next event based on priority. Conceptually, a scheduled release is very similar to a timed override. For example, after the daily schedule ends at 12:00 am (midnight), the schedule releases control over to the next event.

## Creating a Schedule

Symbio™ UI leads you through the process of creating a schedule for your Symbio 800. If you need help completing the steps, click the help icon located on each page. You can create a schedule to control the following points and applications based on time and date:

- Binary outputs and values
- Analog outputs and values
- Multistate outputs and values

Points and applications are referred to as members when they are assigned to a schedule. Members can be assigned to only one schedule during the same effective period. Members must be the correct type; that is, a binary point cannot be included in an analog schedule.

To create a schedule:

1. Click the **create schedule** button. The **Create Schedule—Schedule Information** page appears.
2. Enter a name for the schedule, and select the schedule type and effective dates.
3. Click **next** to continue. The **Create Schedule—Select Members** page appears.
4. From the **selection tree**, select members (spaces and areas) for the schedule, then click **Add** to move to **selected items**.
5. Click **next** to continue. The **Create Schedule – Schedule Times** page appears.
6. Select a schedule default. Each day is independent of the others and always begins with the **schedule default** value. The schedule default value is applied to each day of the week and is the value that the schedule defaults to at 12:00 a.m. for any given day.
7. Add events to the schedule: click **add event**, which opens the event dialog box.
8. Enter a time for when the event will start and select a value.
9. Select the days of the week to which the event will be applied.
10. Click **Add**. The event appears in the schedule viewer. (To edit or delete an event, click on the event in the schedule viewer.)
11. Click **next** to continue. The **Create Schedule – Summary** page appears.
12. Review the schedule. Click **finish** to save the new scheduled as summarized.

## Alarm Configuration

In Symbio™ UI left navigation pane, select **Alarm Configuration**. From the Alarm Configuration screen, you can view and edit alarm categories, alarm message templates, notification classes, routing alarm email, and audible alarm notification.

**Figure 57. Symbio™ UI Alarm Configuration screen**

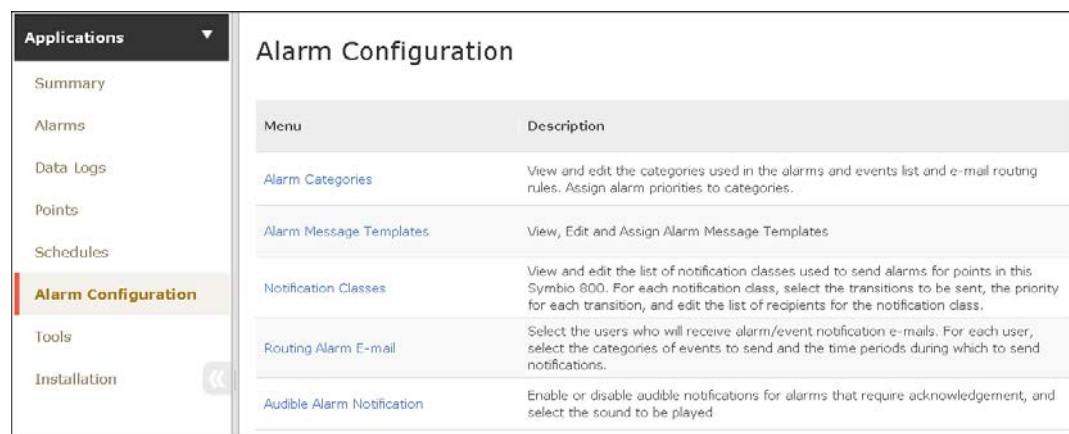

Menu	Description
Alarm Categories	View and edit the categories used in the alarms and events list and e-mail routing rules. Assign alarm priorities to categories.
Alarm Message Templates	View, Edit and Assign Alarm Message Templates
Notification Classes	View and edit the list of notification classes used to send alarms for points in this Symbio 800. For each notification class, select the transitions to be sent, the priority for each transition, and edit the list of recipients for the notification class.
Routing Alarm E-mail	Select the users who will receive alarm/event notification e-mails. For each user, select the categories of events to send and the time periods during which to send notifications.
Audible Alarm Notification	Enable or disable audible notifications for alarms that require acknowledgement, and select the sound to be played

## Tools

To effectively manage Symbio 800, a selection of task-based tools are available. The following tools described in this section are accessible from the Tools page:

- Audit Logs
- Backup and Restore
- BACnet® Information
- Firmware Update

- Programs
- Resource Usage
- System Logs

**Figure 58. Tools menu**

Tool	Description
Audit Logs	View detailed information about user activity on the Symbio 800.
Backup and Restore	Start backup activities for the Symbio 800, or restore the Symbio 800 from an existing backup file.
BACnet Information	View detailed information about BACnet on the Symbio 800.
Firmware Upgrade	To upload the new Firmware file into the Symbio 800.
Programs	View status of programs that are currently running on the Symbio 800.
Resource Usage	View usage of system resources.
System Logs	View and export system logs for the Symbio 800.

From the left navigation menu click **Tools > Backup and Restore**. Backup and Restore is a process that involves creating an exact duplicate of a Symbio 800, exporting (saving) the duplicate copy, and then restoring that copy at a later time. Use the Restore tool to restore the Symbio 800 configuration file that was produced by the backup tool.

It is important to back up Symbio 800 controllers in the event that a system failure occurs. Backups should also be performed prior to upgrading software, adding devices, or adding new applications.

Follow best practices when implementing a backup and restore procedure plan for your system. Backups do not include license files or device firmware.

**Important:** *The micro SD card installed at the factory contains an as-built backup. Additionally, the SD card can store approximately 10 more backups on a First-in First-out basis.*

## BACnet® Information

Information about the BACnet configuration is shown on this page. This information is typically used by Trane Technical Support.

## Firmware Upgrade

Firmware Upgrade allows the user to update the controller from a file located on their PC.

## Programs

Tracer® Graphical Programming (TGP2) programs are created and downloaded to Symbio 800 by using the Tracer TU service tool. To view the status of programs after they have been downloaded to Symbio 800, select **Tools > Programs** from the left navigation menu. The **Programs** list page shows the how often programs in Symbio 800 run and the most recent run time.

Custom TGP2 routines for installed equipment can now be viewed in real-time. Data points in the routine will reflect present value and gets updated for every 15 seconds, regardless of the program run interval.

**Note:** *See the Tracer TU Service Tool Getting Started Guide (BAS-SVU046).*

## Resource Usage

Resource Usage displays system usage such as applications, memory, micro SD card, communication link, and points. This is primarily used by Trane Technical support.

**Figure 59. Symbio UI Resource Usage**

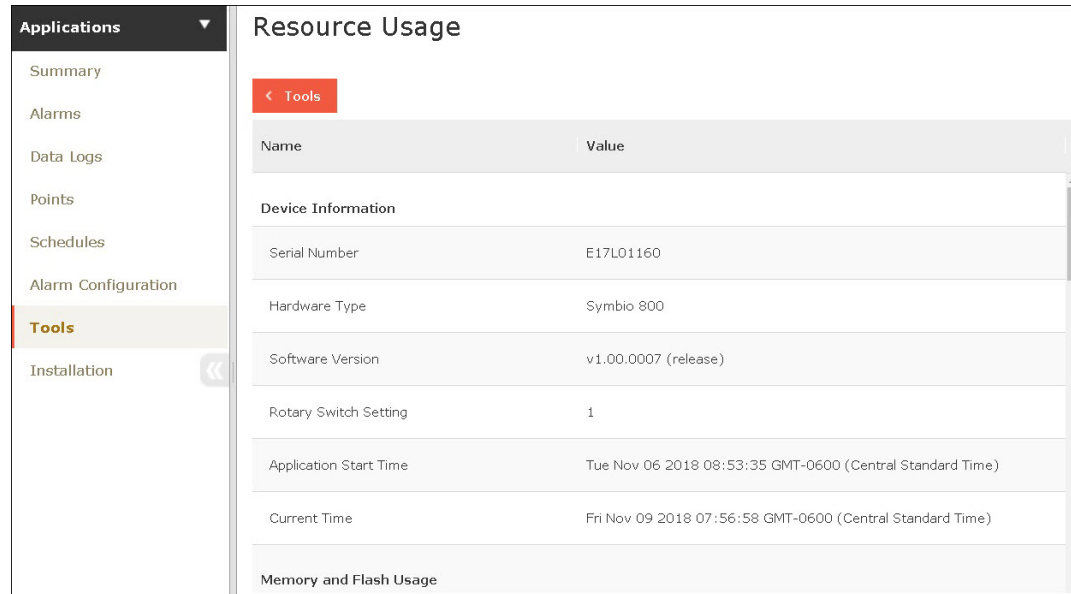

Name	Value
<b>Device Information</b>	
Serial Number	E17L01160
Hardware Type	Symbio 800
Software Version	v1.00.0007 (release)
Rotary Switch Setting	1
Application Start Time	Tue Nov 06 2018 08:53:35 GMT-0600 (Central Standard Time)
Current Time	Fri Nov 09 2018 07:56:58 GMT-0600 (Central Standard Time)
<b>Memory and Flash Usage</b>	

## System Logs

System logs are an advanced informational files that may be requested by Trane Technical Support.

From the left navigation menu click **Tools > System Logs**.

## Installation

These settings are for regional specifications, system units, communications, and licensing. These settings were configured during initial configuration at the factory. Some of these settings can be edited.

**Figure 60. Basic Settings**

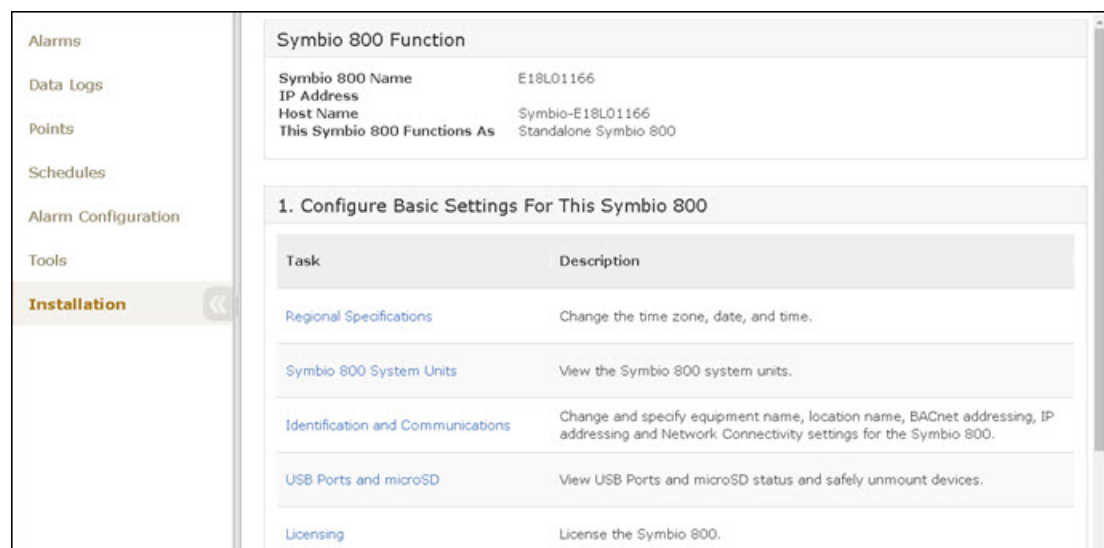

Task	Description
<a href="#">Regional Specifications</a>	Change the time zone, date, and time.
<a href="#">Symbio 800 System Units</a>	View the Symbio 800 system units.
<a href="#">Identification and Communications</a>	Change and specify equipment name, location name, BACnet addressing, IP addressing and Network Connectivity settings for the Symbio 800.
<a href="#">USB Ports and microSD</a>	View USB Ports and microSD status and safely unmount devices.
<a href="#">Licensing</a>	License the Symbio 800.

## Regional Specifications

This link contains time zone, and date and time selections that were made during initial configuration.

**Figure 61. Regional Specifications**

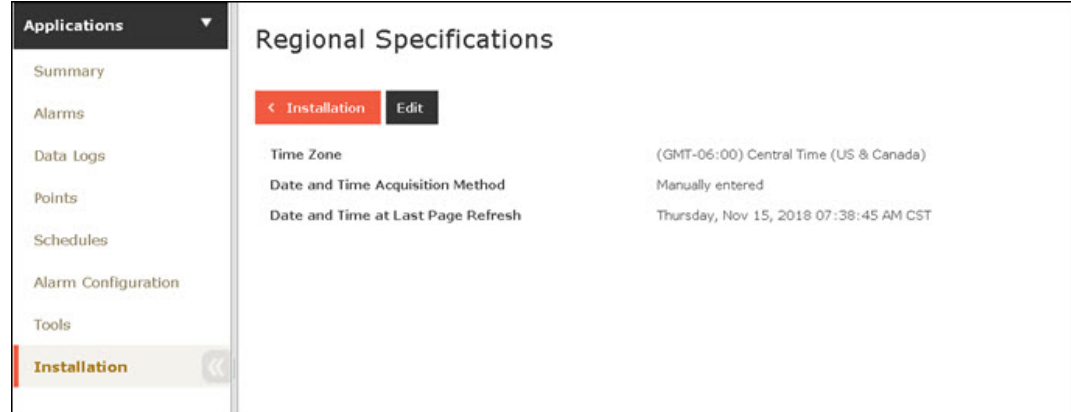

## Symbio™ 800 System Units

This link enables you to view the system units that were selected for the Symbio 800 during initial installation. They cannot be edited.

**Figure 62. Symbio 800 System Units**

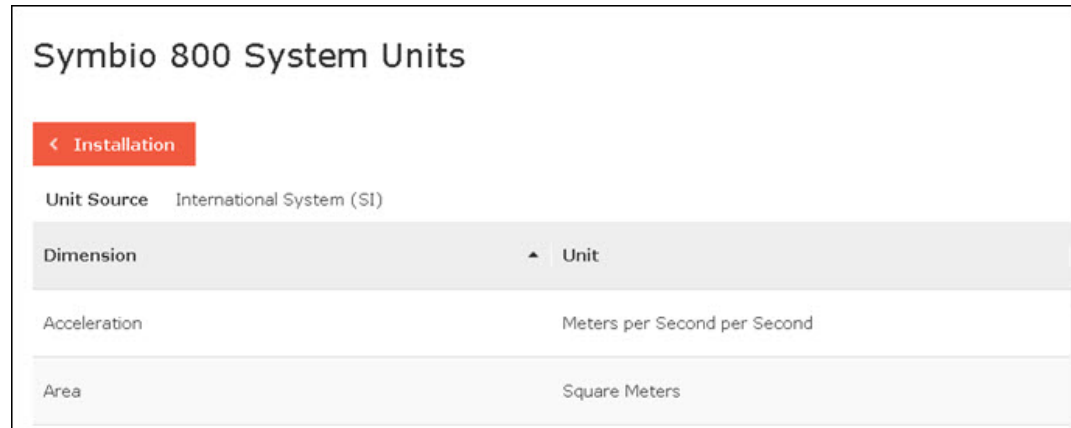

## Identification and Communications

The Identification and Communications page allows you to view and edit configurations for the equipment name, location name, Protocol, IP and network address settings, Air-Fi® configuration, Trane Intelligent Services, and network connectivity. For IT concerns, see BAS-PRB017-EN.

**Figure 63. Identification and Communications**

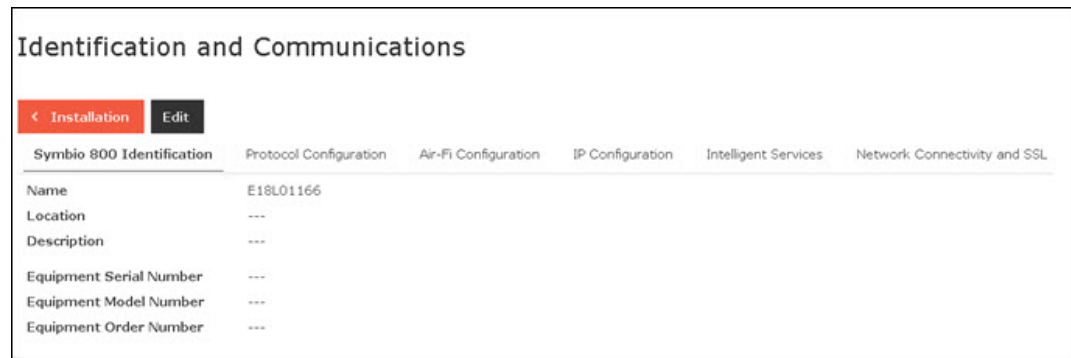

## USB Ports and microSD

On this page, you can view the USB ports and microSD for your Symbio 800. In addition, you can enable and disable individual USB ports and safely unmount mass storage devices from the USB ports and microSD.

**Figure 64. USB Ports and microSD**

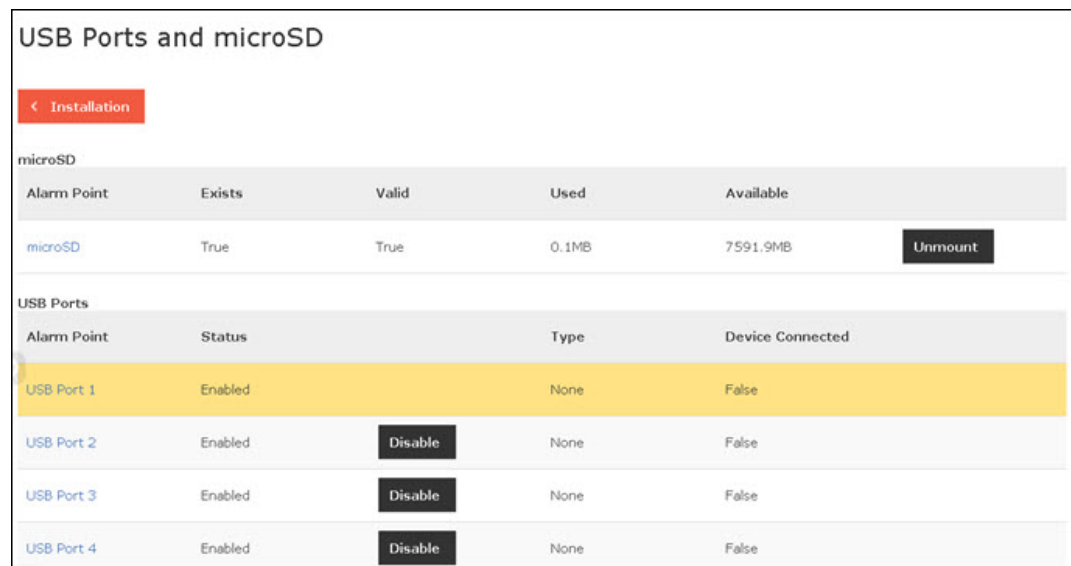

## Licensing

This link opens the Product License page, which allows you to browse for and install a Symbio 800 license.

**Figure 65. Product License**

### Product License

< Installation

**Current License Information**

Current License File	Base License
Features Supported	Trending, Scheduling, Reporting, Alarming
Hardware Serial Number	E18L01166
Software Maintenance Plan Expiration Date	1/19/2038

**New License**

License File

Browse...

Upload License File

## Defaults for User Preferences

The Defaults page shows the formats in which the system displays data. This page is divided into two sections: Regional Preferences and Data Display Units.

**Figure 66. Defaults for User Preferences**

### Defaults For User Preferences

< Installation Edit

**Regional Preferences**

Date Format	Month, Day, Year
Time Format	AM/PM
Number Format	9,999,999.99
Start Day Of Week	Sunday
Preferred Language for E-mail	English

**Data Display Units Preferences**

Unit Source

Inch-Pound (IP)

Dimension ▲ Unit

Acceleration	Feet per Second per Second
Area	Square Feet

## Application Defaults

For setting the alarm capacity for Symbio 800 and hardware alarms priority. Valid range is from 100 to 500 events. Default hardware alarms priority is 250: Information.



**Figure 67. Application Defaults**



## SMTP Settings

Use to set up your Simple Mail Transfer Protocol (SMTP) so that events can be routed to users by e-mail.

**Figure 68. SMTP Settings**

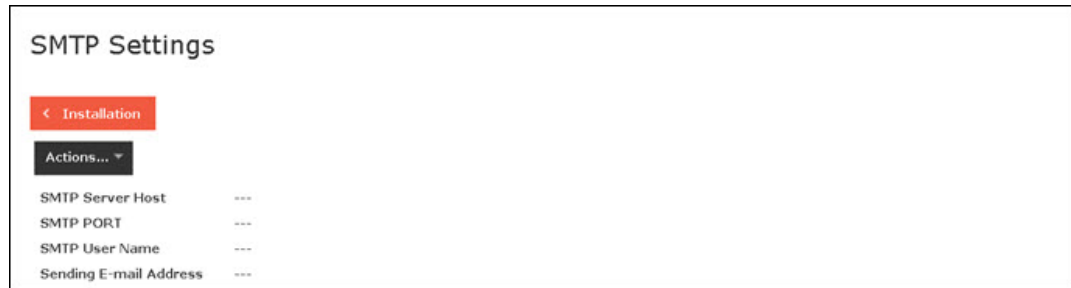

## Priority Levels

Priority levels establish a strategy used by the system to avoid conflicting control by giving precedence to applications with a higher level of priority. Priority levels are configured from installation. They are numbered 1 through 16, with 1 being the highest and 16 lowest.

**Figure 69. Priority Levels**

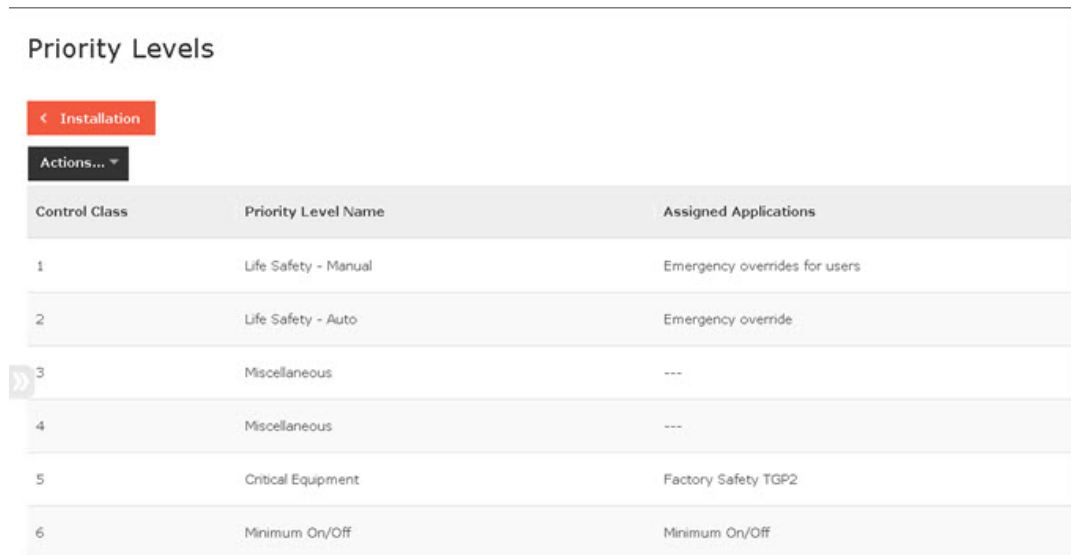

Control Class	Priority Level Name	Assigned Applications
1	Life Safety - Manual	Emergency overrides for users
2	Life Safety - Auto	Emergency override
3	Miscellaneous	---
4	Miscellaneous	---
5	Critical Equipment	Factory Safety TGP2
6	Minimum On/Off	Minimum On/Off

## Login Page

On the Login page you can upload language packs and personalize your login page by adding background images.

**Figure 70. Login Page**

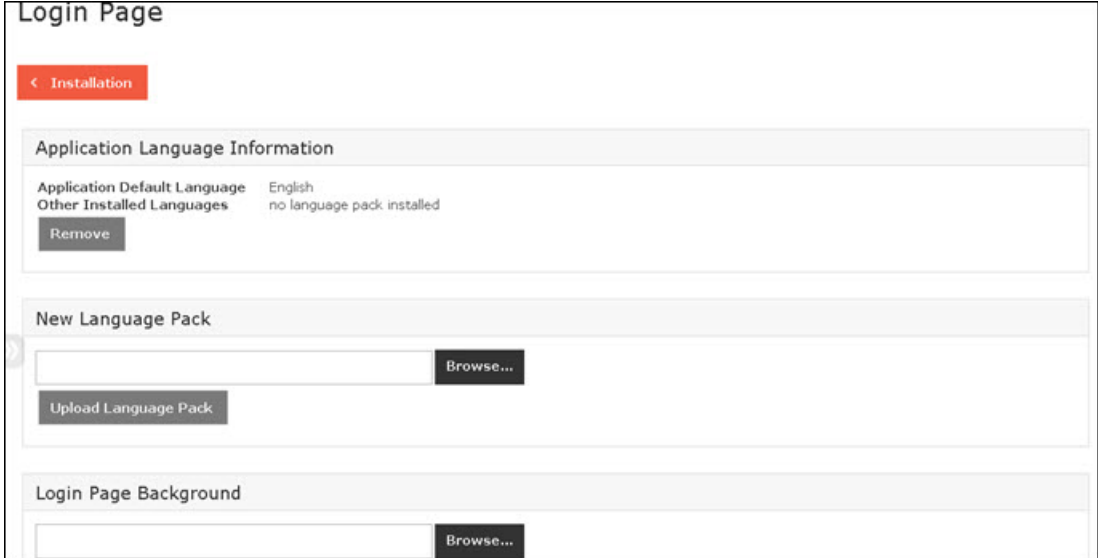

The screenshot shows a web interface titled "Login Page". At the top left, there is a red button labeled "< Installation". Below this is a section titled "Application Language Information" with a light gray header. Inside this section, there are two rows of text: "Application Default Language" with the value "English" and "Other Installed Languages" with the value "no language pack installed". A "Remove" button is located below the second row. Below the "Application Language Information" section is another section titled "New Language Pack" with a light gray header. This section contains a text input field, a "Browse..." button to its right, and an "Upload Language Pack" button below the input field. At the bottom of the interface is a section titled "Login Page Background" with a light gray header, containing a text input field and a "Browse..." button to its right.



# Appendix A. Setting Up Trane Connect Remote Access for Customer

## Registering a Symbio 800 with TIS Command Center

The following procedure describes how to register a new Symbio 800 in the TIS Command Center (mybuilding.trane.com). Trane Offices and Trane technicians use this interface to self-register Symbio 800 in TIS Command Center and to set up Trane Connect.

1. Log on to mybuilding.trane.com. Click on **TIS Command Center**, then click **Site Administration** from the **Welcome** drop-down list. The Account Overview page opens as shown in the following figure.

**Figure 71. Navigating to Site Administration (TIS Command Center)**

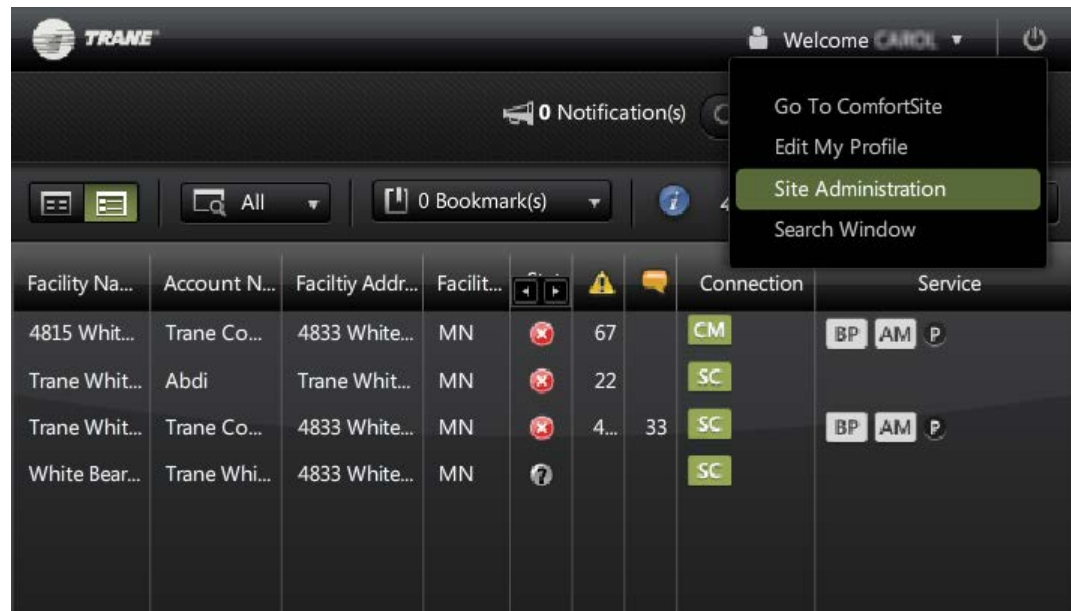

2. In the **Connectivity Information** section, select Symbio 800 from the **Connection Type** drop-down list. Then enter the Symbio 800 hardware serial numbers in the provided fields.
3. In the **Owner/Account Information** section, select an existing account or enter a new one.
4. Enter the name and address of the facility in the provided fields.
5. Select a Trane office from the **Office Name** drop-down list.
6. In the **Admin Email Information** section, enter the name and e-mail address of the individual who will serve as the Trane Connect customer administrator for the facility. (This information is only required if setting up remote access for customers.)

Only two customer Admins can be created for each Symbio 800. The Customer Admin user is the only user who can set up other customer users. A customer user can remotely access a Symbio 800 using Trane Connect.

7. Agree to the Terms and Conditions and then click **Save**.
8. Proceed to " ", if setting up remote access for customers.

**Figure 72. Registering Symbio 800 (TIS Command Center)**

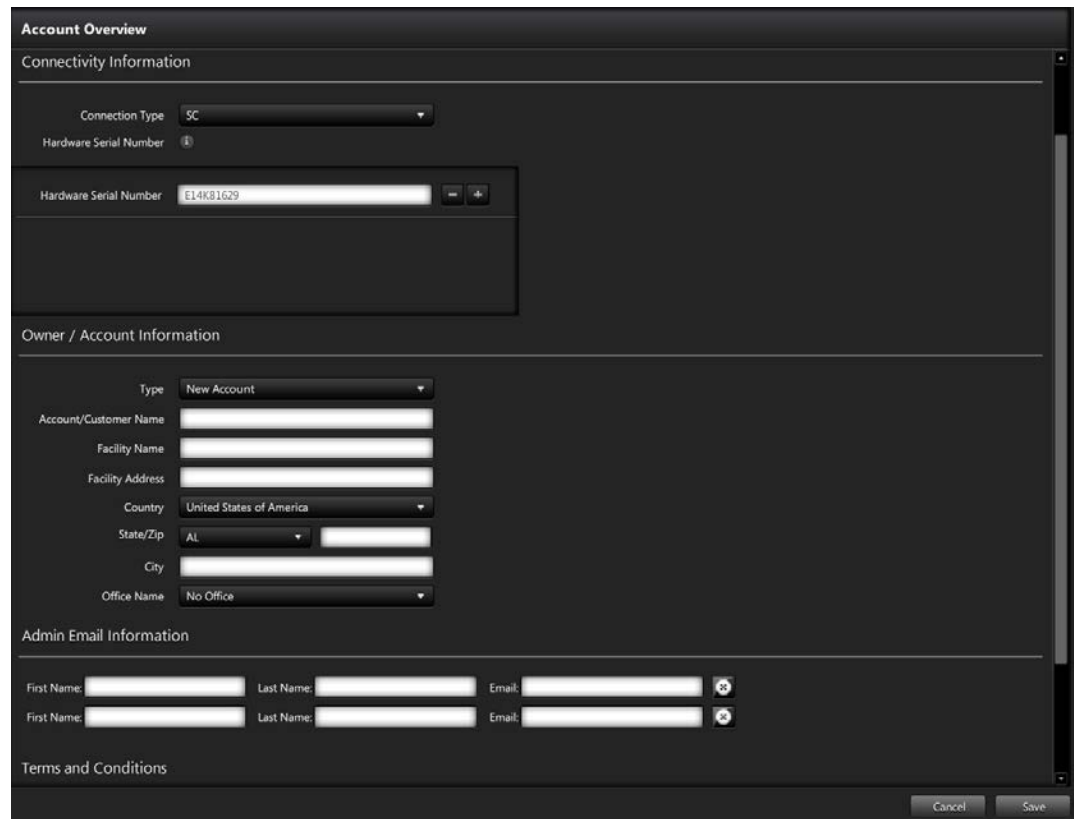

The screenshot shows a web-based registration form titled "Account Overview". It is divided into several sections:

- Connectivity Information:** Includes a "Connection Type" dropdown menu set to "SC" and a "Hardware Serial Number" field with a help icon. Below this is a text input field for the "Hardware Serial Number" containing the value "E14K81629" and a clear button.
- Owner / Account Information:** Includes a "Type" dropdown menu set to "New Account". Below are several text input fields for "Account/Customer Name", "Facility Name", and "Facility Address". There are also dropdown menus for "Country" (set to "United States of America"), "State/Zip" (set to "AL"), "City", and "Office Name" (set to "No Office").
- Admin Email Information:** Contains two rows of input fields for "First Name", "Last Name", and "Email", each with a clear button.
- Terms and Conditions:** A section at the bottom with a checkbox and a "Save" button.

## Modifying a Previously Registered Symbio 800

The following process describes how to add a new customer administrator to an existing Symbio 800 in TIS Command Center (mybuilding.trane.com).

1. In TIS Command Center, select the Symbio 800 (facility) and then click **Edit Facility Settings** from the **Actions** menu (see ).

**Figure 73. Edit a Facility (TIS Command Center)**

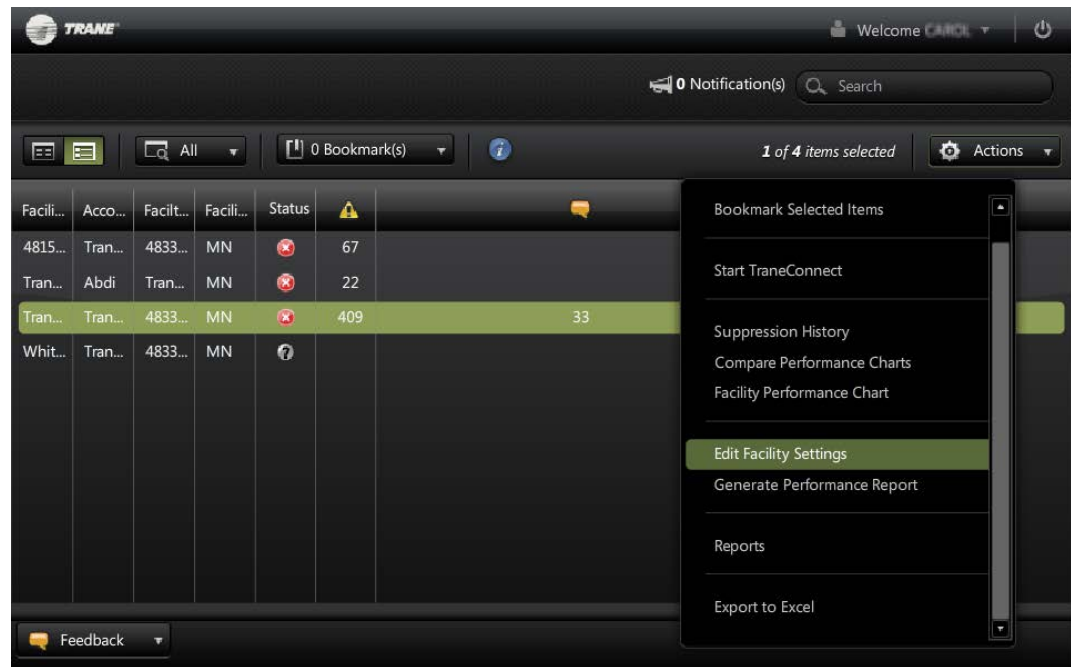

2. From the left-hand menu, click **Account and Connectivity**. The Edit Facilities page opens ().
3. In the **Admin Email Information** section, enter the name and e-mail address of the individual who will serve as the Trane Connect Remote Access customer administrator for the facility. (This information is only required if setting up remote access for customers.)  
Only two customer Admins can be created for each Symbio 800. The Customer Admin user is the only user who can set up other customer users. A customer user can remotely access a Symbio 800 using Trane Connect Remote Access.
4. Agree to the Terms and Conditions and then click **Save**.
5. Proceed to **"/**, if setting up remote access for customers.

Figure 74. Add a customer administrator (TIS Command Center)

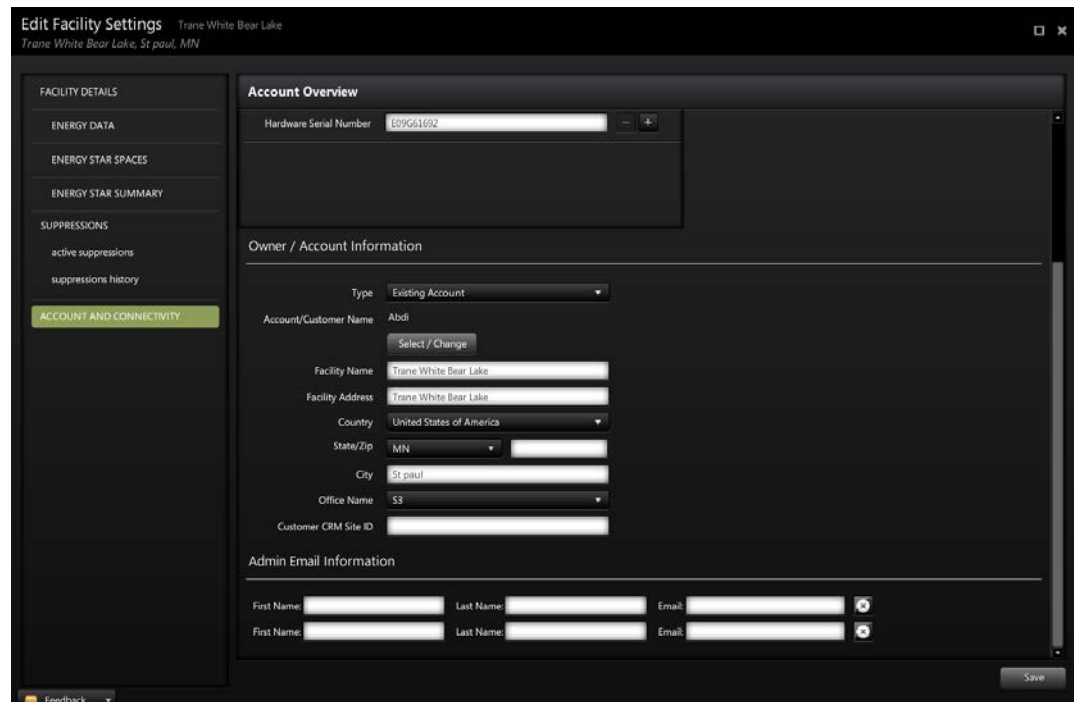

**Edit Facility Settings** Trane White Bear Lake  
Trane White Bear Lake, St paul, MN

**FACILITY DETAILS**

- ENERGY DATA
- ENERGY STAR SPACES
- ENERGY STAR SUMMARY
- SUPPRESSIONS
  - active suppressions
  - suppressions history
- ACCOUNT AND CONNECTIVITY**

**Account Overview**

Hardware Serial Number: E09G61692

**Owner / Account Information**

Type: Existing Account

Account/Customer Name: Abdi  
Select / Change

Facility Name: Trane White Bear Lake

Facility Address: Trane White Bear Lake

Country: United States of America

State/Zip: MN

City: St paul

Office Name: S3

Customer CRM Site ID:

**Admin Email Information**

First Name: Last Name: Email:

First Name: Last Name: Email:

Save

## Creating Initial Customer Account

To authenticate a new customer admin account:

1. Upon receipt of the **Welcome to Trane Connect** e-mail, click on the activation link as shown below.

## Setting Up Trane Connect Remote Access for Customer

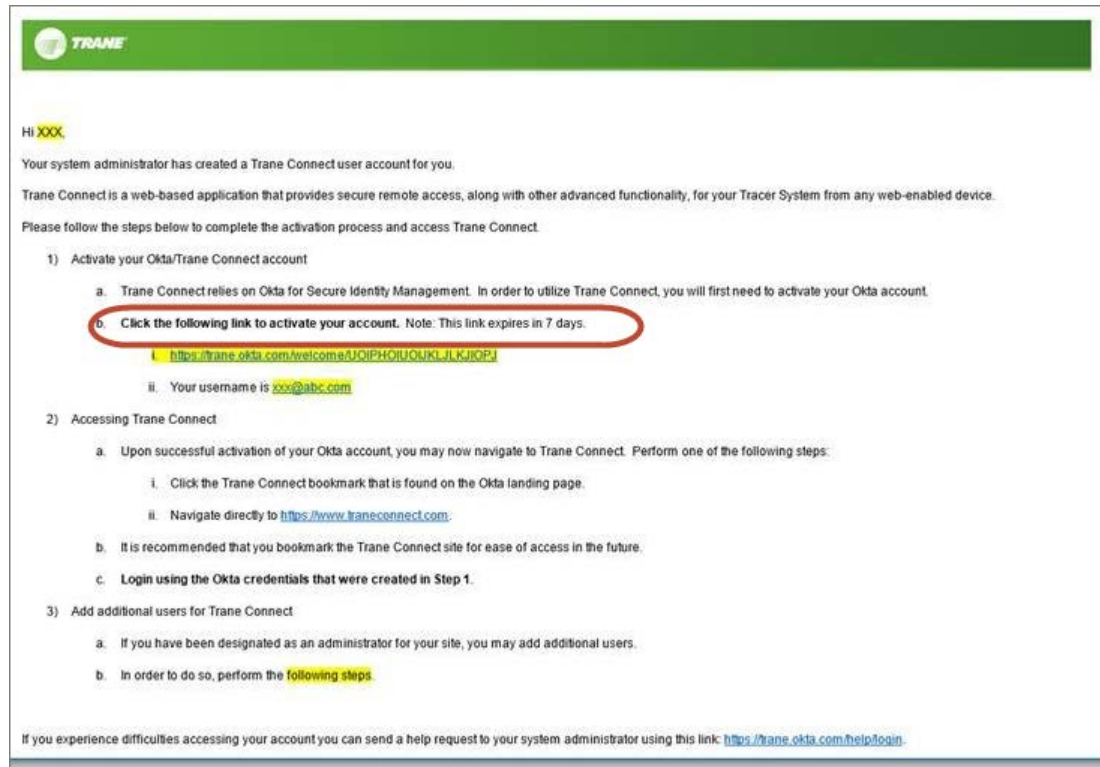

Hi XXX,

Your system administrator has created a Trane Connect user account for you.

Trane Connect is a web-based application that provides secure remote access, along with other advanced functionality, for your Tracer System from any web-enabled device.

Please follow the steps below to complete the activation process and access Trane Connect.

- 1) Activate your Okta/Trane Connect account
  - a. Trane Connect relies on Okta for Secure Identity Management. In order to utilize Trane Connect, you will first need to activate your Okta account.
  - b. Click the following link to activate your account. Note: This link expires in 7 days.**  
<https://trane.okta.com/welcome/SJQIPHOIUQJLJKJOPJ>
  - ii. Your username is [xxx@abc.com](mailto:xxx@abc.com)
- 2) Accessing Trane Connect
  - a. Upon successful activation of your Okta account, you may now navigate to Trane Connect. Perform one of the following steps:
    - i. Click the Trane Connect bookmark that is found on the Okta landing page.
    - ii. Navigate directly to <https://www.traneconnect.com>.
  - b. It is recommended that you bookmark the Trane Connect site for ease of access in the future.
  - c. **Login using the Okta credentials that were created in Step 1.**
- 3) Add additional users for Trane Connect
  - a. If you have been designated as an administrator for your site, you may add additional users.
  - b. In order to do so, perform the [following steps](#).

If you experience difficulties accessing your account you can send a help request to your system administrator using this link: <https://trane.okta.com/help/login>.

**Important:** The customer administrator must activate the link in the e-mail within 7 days or the account activation will expire. Contact your local Trane office for any additional assistance.

2. The account creation screen appears after clicking the activation link. Enter and re-enter a new password, select a security question/answer, and select a security image that will be presented upon subsequent logins. Upon successful account creation and login, the customer activation screen appears

## Setting Up Trane Connect Remote Access for Customer

Welcome to Trane Inc. - Prod, Jeff!  
Create your Trane Inc. - Prod account

 Enter new password

Your password must have at least 8 characters, a lowercase letter, an uppercase letter, a number, a symbol, no parts of your username.

Repeat new password



 Choose a forgot password question



What was the mascot of the first sports team you played on? ▾

Answer

 Click a picture to choose a security image

Your security image gives you additional assurance that you are logging into Okta, and not a fraudulent website.

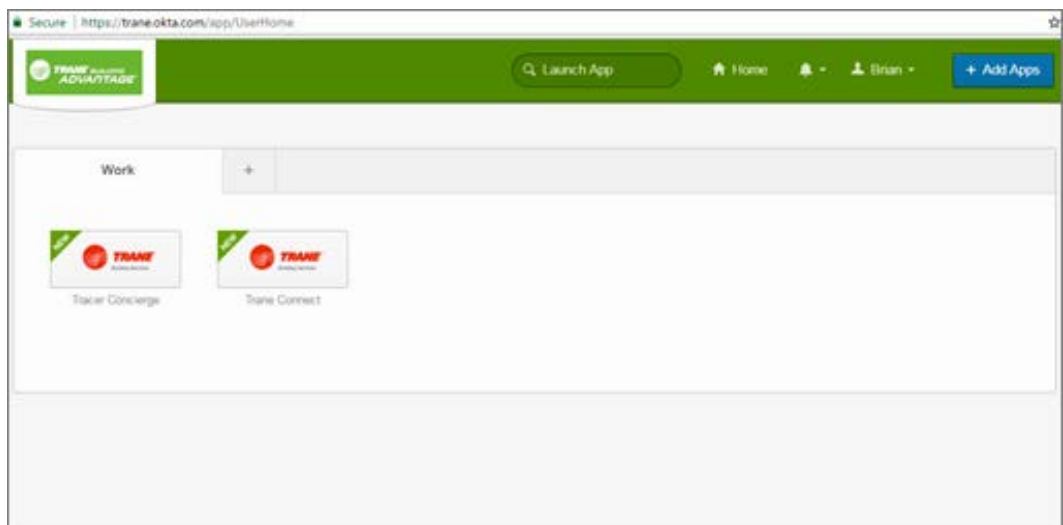

3. Click the Trane Connect image to launch [traneconnect.com](https://traneconnect.com).

**Note:** Customers who have more than one site will see a list of multiple sites.



# Initial Login to Trane Connect

After customer administrators have activated their accounts from the Welcome to Trane Connect e-mail, they are now able to access Trane Connect.

1. Navigate to [traneconnect.com](http://traneconnect.com) to access the Trane Connect login page.
2. Enter the credentials that were created in the Customer Account Creation procedure and then click the Login button. The Connect to a Device page opens and displays a list of devices that you can securely connect to.

**Note:** It is recommended that users create a bookmark for [traneconnect.com](http://traneconnect.com).

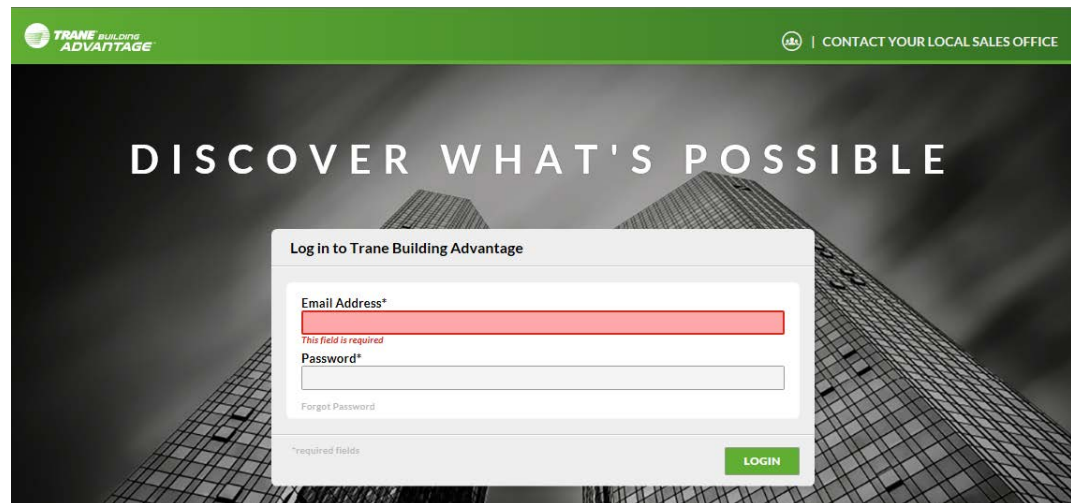

3. Select the desired device to connect to and click on the **CONNECT** button under the LAUNCH DEVICE column. A new browser tab displays a login page for the device (Tracer Synchrony or Tracer Concierge).

**Note:** Multiple devices can be accessed simultaneously in separate browser tabs.

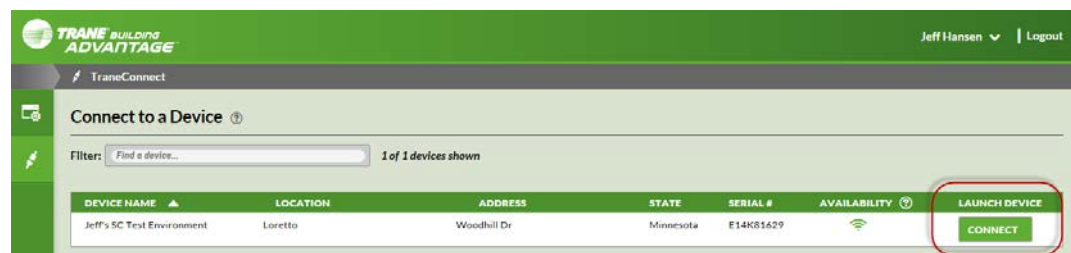

# Creating Additional Trane Connect Users

Customer admins have the ability to create and delete accounts for additional users for each device.

1. Log into Trane Connect. Click the **Set Up** icon located at the top of the left navigation menu and then select **User Management**. A list of current users is displayed.

# Setting Up Trane Connect Remote Access for Customer

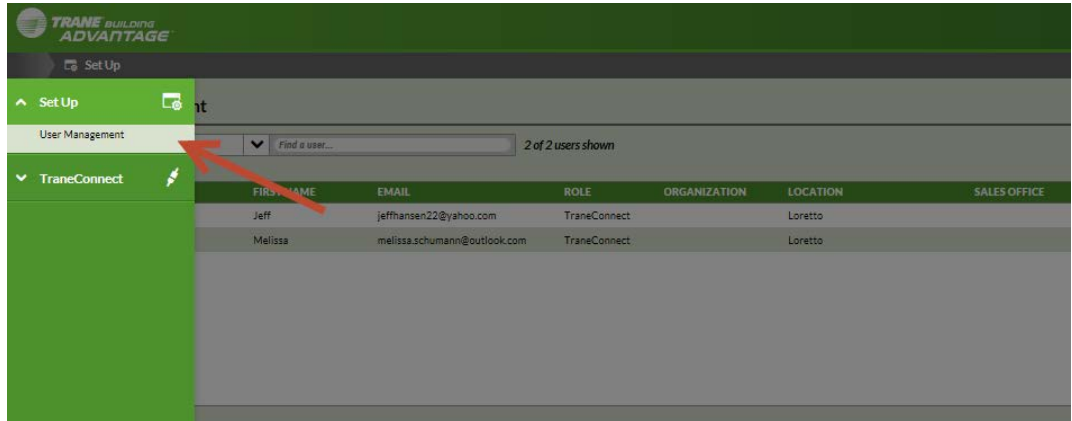

2. From the upper-right portion of the screen, click **Create New User**.

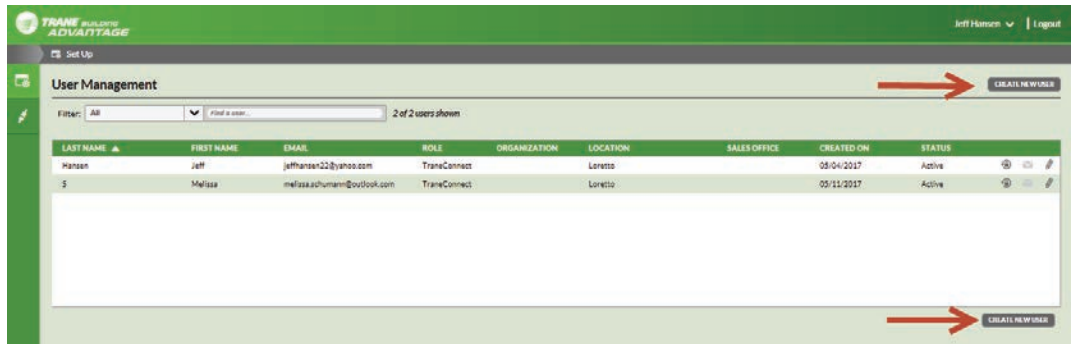

**Add User**

Select organizations or locations  
 Select Organizations or Locations:  
 Find an object...  
 ORGANIZATION  
 Jeff's Test 00

**Overview**

First Name\*  
 Last Name\*  
 Email Address\*  
 Confirm Email Address\*  
 Role(s)\*  
 Select all  
 TraneConnect  
 Secondary Email

Create another user **SAVE USER** **CANCEL**

## Setting Up Trane Connect Remote Access for Customer

3. Search for the user's location/organization in the search box. Enter the user information, Trane Connect role, and appropriate devices for the user.
4. Click **Save User** and the user will receive a *Welcome to Trane Connect* e-mail. The user has 7 days to activate the link in the e-mail or else the account activation expires. If the user requests the e-mail be resent or wants to edit the user profile, they click the appropriate icon located in the individual user list as shown below.



## Security

Symbio 800 network security can be enhanced by limiting user access over the IP network, restricting access to HTTPS only, and disabling the user interface through a Web browser. The customer's IT staff should be consulted when setting up enhanced security.



## Appendix B. Troubleshooting

### Communication Problems

**Problem:** Symbio 800 is not communicating with Tracer SC, but can communicate with Tracer TU using a direct USB connection.

**Possible cause:** The "Soft Set Device ID" check box was unchecked after the Symbio 800 was installed onto the Tracer SC.

**Possible solution:** Reinstall the Symbio 800 device onto the Tracer SC.

- Verify that the Symbio 800 device ID is set to the rotary address, which is found in TracerTU/controller/controller settings/protocol.
- Log on to Tracer SC and navigate to the **Devices** page; select the Symbio 800 device from the list, then select **replace** from the actions button.

**Alternative cause:** The baud rate changed in the controller settings.

**Solution:** In Tracer TU, open the Controller Settings page. Set the baud rate to match the baud rate on the Tracer SC TP link.

**Alternate Cause:** The rotary switch is not set properly or another device on the same TP link is set to the same rotary address.

**Solution:** Verify that the rotary address is correct. If not, change the address and cycle power. If the device was previously installed in the Tracer SC, the device may need to be "replaced" from the Tracer SC **Devices** page.

**Alternate Solution:** If the device is set to the proper rotary address, then another device(s) could be using the same rotary address on the TP link.

- Power down the Symbio 800 and discover the link with Tracer SC to see if a duplicate device is present.
- Change address of duplicate device, then reapply power the Symbio 800. If previously installed, the device may need to be replaced in the Tracer SC.

## Output Points

**Problem:** Output points are not being controlled by the Symbio 800.

**Possible cause:** The output point was not configured properly in Tracer TU.

**Solution:** Verify the hardware configuration in Tracer TU and change as needed.

**Problem:** The value of an analog point reads correctly in Tracer TU but does not read correctly in the Tracer SC.

**Solution:** Verify that the dimensionality was set properly on the point configuration page of TU. Log on to Tracer SC and navigate to the **Devices** page; select the Symbio 800 device from the list, then select **replace** from the **actions** button.

**Alternate solution:** Verify that the equipment template is pointing to the proper output point in the Symbio 800.

**Problem:** The output point is out of service.

**Solution:** Place point in service from either Tracer TU, Symbio 800, or Tracer SC.

## Force Return to Factory Defaults (Using 999)

In some cases, a corrupt database or similar problem may prevent you from accessing the Tracer Synchrony user interface in order to return the Symbio 800 controller to factory defaults.

If this occurs, do the following to return to factory defaults:

1. Power down the Symbio 800.
2. Reset the rotary switches to "999."
3. Power up the Symbio 800.  
The 7-segment display shows F, o, r, C, E.
4. Within 30 seconds, set the rotary switches to the intended normal value.  
The 7-segment display shows C, L, E, A, r, indicating that the database is being cleared. It will then resume normal operation showing -L on the 7-segment display during startup and then "dancing dashes."

**Note:** *If rotary switches are not reset within 30 seconds, the Symbio 800 will power down leaving the database intact.*

5. Equipment operation can be restored after clearing with either Tracer TU or a backup file to restore.
6. This procedure (999) will not clear the license file.

**Note:** *The preferred method for to reset a Symbio 800 to its factory settings is to restore the baseline backup.*

## Recovery (USB Memory Stick and 997 or 998)

**Note:** *This recovery process should only be done when in contact with Technical Support.*

In the event the Symbio 800 becomes unresponsive, you can attempt to recover it by following the instructions below.

1. Insert the USB memory stick with the Symbio 800 firmware (.scfx) file into any one of the USB ports on the Symbio 800 system controller.
2. Set the rotary switches on the Symbio 800 to **998** and cycle power (or power up if already off). Or, set the rotary switches for **999** to return to factory defaults, as previously explained.

Upon power-up, the Symbio 800 will complete the recovery process. When complete, the 7-Segment display will return to "dashing dances."

3. 997 Vs 998: The USB stick with 998 or 997 replaces all the firmware and other files.
  - Restoring with 997 is similar to replacing with a new controller. 997 clears the license file. Without a license file, TGP2 trending, scheduling, reporting, and alarming are not possible.
  - Restoring with 998 is intended to preserve the license file and configuration, if possible. The process attempts to read the files from the damaged file system, store them on the USB stick, and write them back to the controller after the restoration.

## Reload Application Firmware

To change firmware on the Symbio 800, load the desired .scfx file with the Symbio 800 Web UI or Tracer TU.



## Appendix C. Firmware Updates

Symbio 800™ software upgrades can be performed at the Symbio UI, with a USB memory stick, or with Tracer TU File Transfer Utility.

### Symbio UI

A service tool is no longer required to upgrade/downgrade Symbio 800 and can be performed from the Symbio UI. Navigate to the **Tools** page and select the **Firmware Upgrade** tab. Browse to the Firmware file stored on your PC,, select the firmware file and then click **Upload**. The Symbio 800 will process the upgrade and you will be returned to the log in screen.



Trane - by Trane Technologies (NYSE: TT), a global innovator - creates comfortable, energy efficient indoor environments for commercial and residential applications. For more information, please visit [trane.com](http://trane.com) or [tranetechnologies.com](http://tranetechnologies.com).

Trane has a policy of continuous product and product data improvements and reserves the right to change design and specifications without notice. We are committed to using environmentally conscious print practices.

BAS-SVX080B-EN 01 Apr 2021  
Supersedes BAS-SVX080A-EN (January 2021)

©2021 Trane